



update
displays

Frame your future!

Katalog 2024



Das macht uns aus...

NACHHALTIGKEIT:

Wir sind uns unserer unternehmerischen, sozialen und gesellschaftlichen Verantwortung bewusst. Wir handeln nachhaltig und umweltfreundlich!

HERSTELLUNG:

In unseren Produktionsstätten in Deutschland und der Türkei arbeiten unsere Mitarbeiter mit Liebe zum Detail an unseren Produkten.

KREATIVITÄT:

Wir machen Ihren Wunsch mit unseren modernen Fertigungstechnologien zur Realität! Dabei begleitet Sie unser erfahrenes Team von der Idee, über das Design bis zum fertigen Produkt.

QUALITÄT:

Beste Qualität und praxisorientierte Funktion stehen bei unseren Produkten im Vordergrund.

VIELFALT:

Die hochwertige Standardausstattung für Point of Sale, HORECA, Office, Stadtmobiliar und Promotion erweitern wir fortlaufend um neue und innovative Produkte.

UMWELT:

Ökologisch denken und handeln!
Ressourcen schonen. Dazu leisten auch wir unseren Beitrag indem wir Produkte mit sinnvollen Verfahren herstellen, Plastik in Produkten und Verpackung reduzieren, auf recyclebare und nachwachsende Rohstoffe setzen sowie in der Produktentwicklung schon auf Langlebigkeit und Austauschbarkeit von Komponenten achten.

SERVICE:

Grafikproduktion, Montage und Lagerung runden unsere Angebotspalette ab.

LOGISTIK:

Fast alle unsere Produkte werden innerhalb 24 Stunden versendet.

PARTNER:

Kontinuität in der Zusammenarbeit mit Kunden, Lieferanten und auch unseren Mitarbeitern ist die Basis für die Qualität unserer Leistung.

update displays gmbh

Melih Seyis

Geschäftsführer



We stand for...

SUSTAINABILITY:

We are aware of our entrepreneurial, social and environmental responsibility. We act sustainably and environmentally friendly!

PRODUCTION:

In our production sites in Germany and Turkey, our employees work with great attention to detail on our products.

CREATIVITY:

We make your wish come true with our modern production technologies! Our experienced team accompanies you from the idea, to the design, to the finished product.

QUALITY:

Our products focus on the best quality and practice-oriented function.

DIVERSITY:

The high-quality standard equipment for point of sale, HORECA, office, urban furniture and promotion is continually extended by new and innovative products.

ENVIRONMENT:

Thinking and acting ecologically!
Protecting resources - we also make our contribution by manufacturing products with sensible practises, reduce plastic in products and packaging, rely on recycleable and renewable raw materials, and already pay attention to the durability and exchangeability of components in product engineering.

SERVICE:

Our range of services also includes graphic production, assembly and storage.

LOGISTIC:

Almost all of our products are shipped within 24 h.

PARTNER:

Continuity in cooperation with customers, suppliers and also our employees is the basis for the quality of our performance.

update displays gmbh

Melih Seyis

Managing Director



Inhaltsverzeichnis | Table of contents

HORECA, Shop & Desktop Displays <i>HORECA, Shop & Desktop Displays</i>	4 – 13	Informations- und Schutzsysteme <i>Information and protection systems</i>	42 – 52	Outdoor Systeme <i>Outdoor Systems</i>	74 – 76
Postersysteme <i>Poster Systems</i>	14 – 26	Prospekt- und Kombinationssysteme <i>Brochure and Modular stands</i>	53 – 63	Office Produkte <i>Office Products</i>	77 – 80
Leuchtsysteme <i>Illuminated Products</i>	27 – 30	Textil-Spannrahmen <i>Textile Stretchframes</i>	64 – 66	Zubehör <i>Accessoires</i>	81 – 83
Kundenstopper <i>Pavement Signs</i>	31 – 41	Messesysteme <i>Exhibition Systems</i>	67 – 73	Allgemeine Liefer- und Zahlungsbedingungen <i>General terms of delivery and payment</i>	84 – 85

Erklärung der Symbole | Explanation of symbols

	Grün = hoher Lagerbestand <i>Green = High Stock</i> Gelb = geringer Lagerbestand <i>Yellow = Low Stock</i> Rot = wird produziert <i>Red = In Production</i>		LED LED		Made in Europe <i>Made in Europe</i>
	Wasserfest – geeignet für den Außeneinsatz <i>Waterproof – suitable for outdoor use</i>		Grafikproduktion auf Anfrage möglich <i>Print on request available</i>		Made in EU <i>Made in EU</i>
	Abschließbar <i>Lockable</i>		Sondergrößen möglich <i>Special sizes available</i>		„CE-zertifiziert“ <i>„CE-certified“</i>
	Für den Inneneinsatz geeignet <i>Only suitable for indoor use</i>		Smart Home Steuerung <i>Smart home control</i>		Werkzeuglose Montage <i>Toolless assembly</i>
	Für den Außeneinsatz geeignet <i>Suitable for outdoor use</i>		Leicht <i>Light weight</i>		Schwer entflammbar <i>Flame resistant</i>
	Einfacher Plakatwechsel <i>Easy poster change</i>		Sehr standfest <i>Excellent stability</i>		1 Jahr Gewährleistung <i>1 Year Warranty</i>
	Im Hoch- und Querformat nutzbar <i>Usable in portrait and landscape format</i>		Patentiert <i>All rights reserved</i>		Paketdienstfähig <i>Parcel service capable</i>
	Nachhaltig <i>Sustainable</i>		Baukastensystem <i>Modular System</i>		

Holz Kundenstopper MULTI | Wooden A-Board MULTI



- Der Allrounder!
- Outdoor Plakatständer aus zertifiziertem, massivem Buchenholz, dunkel lasiert
- Optimaler Plakatschutz durch mitgelieferte Magnetfolien
- Stabile Metall-Scharniere und Traverse
- Ohne Magnetfolie auch nutzbar als Kreidetafel
- Beschreibbar und feucht oder nass abwischbar
- Ausführung in schwarz, Buche hell oder Eiche auf Anfrage!

- The all-rounder!
- Outdoor poster stand made of certified, solid beech wood, dark glazed
- Optimum poster protection thanks to the supplied magnetic foils
- Sturdy metal hinges and locker
- Without magnetic foil also usable as chalkboard
- Writable and moist or wet wipeable
- Version in black, light beech wood or oak on request!



Art.-Nr.	Plakatmaß (mm)
UWODD00000X5003	DIN A2 / 420 x 594
UWODD00000X5001	DIN A1 / 594 x 841
Art.-Nr.	Beschreibung
UYUP085000X5040	Magnetfolie DIN A1
UYUP009000X5047	Magnetfolie DIN A2
9000014	Kreidestifte 8 er Set

Holz Kundenstopper MULTI Plus | Wooden A-Board MULTI Plus



- Der Alleskönner mit integriertem Top-Schild
- Outdoor Plakatständer aus massivem, zertifiziertem Buchenholz, dunkel lasiert
- Optimaler Plakatschutz durch Magnetfolie (2 Stk. im Lieferumfang enthalten)
- Stabile Metall-Scharniere und Traverse
- Ohne Magnetfolie auch nutzbar als Kreidetafel (Beschreibbar und feucht oder nass abwischbar)
- Einfacher Top-Schild Wechsel durch seitlichen Einschub mit Abdichtung
- Ausführung in schwarz und Buche hell auf Anfrage!

- The all-rounder with an integrated top shield
- Outdoor poster stand made of certified, solid beech wood, dark glazed
- Waterproof thanks to magnetic cover sheet (2 pieces included in delivery)
- Stable metal hinges and lock
- Can also be used as a chalkboard without magnetic cover sheet (can be written on and wiped with a damp or wet cloth)
- Easy change of header thanks to a lateral insertion – closed by a seal
- Version in black and light beech wood on request!

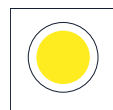

Art.-Nr.	Plakatmaß (mm)	Topschild (mm)
UWOPD000A1X5000	594 x 841	594 x 200
UWOPD000A2X5000	420 x 594	420 x 200
UWOPD000B2X5000	500 x 700	500 x 200
Art.-Nr.	Beschreibung	
9000014	Kreidestifte 8 er Set	

Holz Kundenstopper Economy Indoor | *Wooden A-Board, Economy Indoor*

- Gehwegtafel aus zertifiziertem, massivem Buchenholz, natur
- Schwarze MDF-Kreidetafel
- Beschreibbar und feucht abwischbar mit einem Microfaser Tuch
- *Ausführung in schwarz und Buche dunkel auf Anfrage!*

- *Pavement sign made of certified, solid beech wood, nature*
- *Black MDF-chalkboard*
- *Writable and wet wipeable with a microfibre cloth*
- *Version in black and dark glazed beech wood*



Art-Nr.	Beschreibung	Abmessung (mm)	Schreibfläche (mm)
UWID006078X2000	Kundenstopper	670 x 1030 x 725	590 x 780
9000014	Kreidestifte 8er Set		

NEU! Holz Kundenstopper Indoor Light | *NEW! Chalk A-Board Indoor Light*

- Gehwegtafel aus dunkel lasiertem Kiefernholz
- Schwarze MDF-Kreidetafel
- Beschreibbar und feucht abwischbar mit einem Microfaser Tuch
- *Ausführung in schwarz auf Anfrage!*

- *Pavement sign made of dark glazed fir wood*
- *Black MDF chalkboard*
- *Writable and damp wipeable with a microfiber cloth*
- *Version in black on request!*

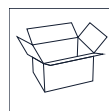
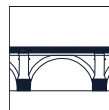

Art-Nr.	Beschreibung	Abmessung (mm)	Schreibfläche (mm)
1702010	Kundenstopper	510 x 900	440 x 660
9000014	Kreidestifte 8 er Set		

Holz Kundenstopper Economy Outdoor | *Wooden A-Board Economy Outdoor*



- Gehwegtafel aus zertifiziertem, massivem Buchenholz, dunkel lasiert
- Schwarze mit Tafellack bedruckte Stahl-Rückwand
- Beschreibbar, feucht oder nass abwischbar und magnethaftend
- Metall-Scharniere und Traverse
- *Ausführung in schwarz lasiert oder Eiche auf Anfrage!*
- *Pavement sign made of certified, solid beech wood, dark glazed*
- *Black steel chalkboard*
- *Writable, moist or wet wipeable and magnetic*
- *Metal hinges and traverse*
- *Version in black glazed or oak on request!*



Art.-Nr.	Schreibfläche (mm)	
UWODD04668X2000	460 x 680	
UWODD06012X2000	600 x 1200	
Art.-Nr.	Beschreibung	Farbe
9000014	Kreidestifte 8er Set	bunt
UYUP397000X1000	Magnete DM = 20 mm, 10er Set	
UPCM0800A4X2000	PET Pocket	schwarz

Holz Kreidetafel Buche | *Wooden Chalkboard beech*



- Angebotstafel für Gastronomie und Hotellerie
- Optimal für den täglichen Gebrauch dank solidem Vollholz-Rahmen aus zertifiziertem Buchenholz, dunkel lasiert
- Beschreibbar mit Kreide oder Kreidemarker und feucht abwischbar mit einem Microfaser Tuch
- *Chalkboard for gastronomy and hotel industry*
- *Solid wood frame made of certified beech wood, dark glazed*
- *Writable with chalk and chalk markers and wet wipeable with a microfibre cloth*

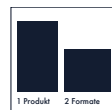

Art.-Nr.	Beschreibung	Außenmaß (mm)	Schreibfläche (mm)
UWSSD10034X5000	Kreidetafel	380 x 480	300 x 400
UWSSD10046X5000	Kreidetafel	480 x 680	400 x 600
UWSSD10049X5000	Kreidetafel	480 x 980	400 x 900
UWSSD10068X5000	Kreidetafel	680 x 880	600 x 800
UWSSD10061X5000	Kreidetafel	680 x 1230	600 x 1150
UWSSD10081X5000	Kreidetafel	880 x 1280	800 x 1200
9000014	Kreidestifte 8er Set		

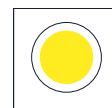
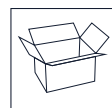

NEU! Holz Kreidetafel Economy | NEW! Wooden Chalkboard Economy

- Angebotstafel für Gastronomie und Hotellerie
- Optimal für den täglichen Gebrauch dank solidem Vollholz-Rahmen aus lasiertem Kiefernholz
- Beschreibbar mit Kreide oder Kreidemarker und feucht abwischbar mit einem Microfaser Tuch
- *Chalkboard for gastronomy and hotel industry*
- *Solid wood frame made of glazed fir wood*
- *Writable with chalk and chalk markers and wet wipeable with a microfibre cloth*



Art.-Nr.	Beschreibung	Außenmaß (mm)	Schreibfläche (mm)
1700012	Kreidetafel	470 x 600	400 x 530
1700013	Kreidetafel	470 x 790	400 x 720
1700014	Kreidetafel	600 x 870	530 x 800
9000014	Kreidestifte 8er Set		

Holz Kreidetafel MEMO | Wooden Chalkboard MEMO

- Magnethaftende Kreidetafel aus Kiefernholz
- Ideal für Kreidemarker und Magnete
- Beschreibbar und feucht oder nass abwischbar
- Integrierte Stiftablege
- *Magnetic chalkboard made of pine wood*
- *Ideal for use of chalk markers and magnets*
- *Writable and moist or wet wipeable*
- *Integrated shelf*

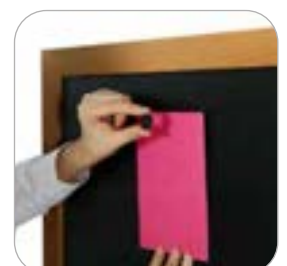
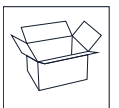
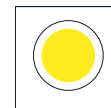

Art.-Nr.	Beschreibung	Abmessungen (mm)	Schreibfläche (mm)
UWNLWDD0F2X2000	Kreidetafel	86 x 502 x 108	400 x 600
9000014	Kreidestifte 8er Set		

Holz Info Aufsteller FLOOR | *Wooden Info Stand FLOOR*

- Freistehende Infotafel aus hellem Kiefernholz
 - Magnethaftendes Whiteboard
 - Ideal für Kreidemarker, Magnete und Infotaschen
 - Klappbare Rückenstütze für stabilen Stand
- *Floorstanding info board made of fir wood, nature*
 - *Magnetic whiteboard*
 - *Ideal for chalk markers, magnets and magnetic poster pockets*
 - *Foldable back support for a stable stand*



Art.-Nr.	Ausführung	Abmessung (mm)
UWDFSOD010X2000	Aufsteller	440 x 770
UWDFSOD020X2000	Aufsteller	440 x 1020
UWDFSOD030X2000	Aufsteller	440 x 1370
9000014	Kreidestifte 8er Set	



440 x 770 mm



440 x 1020 mm



440 x 1370 mm

Holz Kreidetafel Aufsteller FLOOR | *Wooden Chalkboard FLOOR Stand*

- Freistehende Werbetafel aus Buchenholz, dunkel lasiert
 - Kreidetafel aus MDF
 - Klappbare Rückenstütze für stabilen Stand
 - Mit Kreidemarkern beschreibbar
 - Feucht oder nass abwischbar
- *Floorstanding board made of beech wood, dark glazed*
 - *MDF chalkboard*
 - *Foldable back support for a stable stand*
 - *With chalk markers writable*
 - *Moist or wet wipeable*



Art.-Nr.	Ausführung	Abmessung (mm)
UWCFSOD010X2000	Aufsteller	440 x 770
UWCFSOD020X2000	Aufsteller	440 x 1020
UWCFSOD030X2000	Aufsteller	440 x 1370
9000014	Kreidestifte 8er Set	



440 x 1370 mm



440 x 1020 mm



440 x 770 mm



Holz Tischaufsteller VINTAGE | Wood Menu Holder VINTAGE

- Tischaufsteller aus Buchenholz, dunkel lasiert
- Integrierte Einschub Nut
- Kombinierbar mit Kreidetafel oder Acryl-Poster Tasche

- Menu holder made of beech wood, dark glazed
- Inbuilt groove
- Can be used with chalkboard panel or acrylic pocket



Art.-Nr.	Beschreibung	Format
1707001	Tischaufsteller mit Kreidetafel	DIN A5 Hochformat
1707002	Tischaufsteller mit Kreidetafel	DIN A4 Hochformat
1707003	Tischaufsteller mit Acryltasche	DIN A5 Hochformat
1707004	Tischaufsteller mit Acryltasche	DIN A4 Hochformat
9000014	Kreidestifte 8er Set	



Holz Klemmbrett Desk | Wood Clipboard Desk

- Freistehendes Klemmbrett, dunkel lasiert
- Ideal für Tisch Dekorationen und Preisauszeichnungen
- Doppelseitig nutzbar
- Zusätzlich beschreibbar mit Kreidemarkern

- Freestanding clipboard, dark glazed
- Ideal for table decorations and price tags
- Can be used double sided
- Can also be used for chalk markers



Art.-Nr.	Format (mm)	Farbe
UWBCD00A4X2000	210 x 297	Dunkel
Art.-Nr.	Beschreibung	Farbe
9000014	Kreidestifte 8er Set	bunt

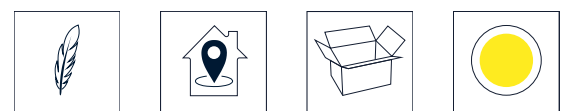

Holz Klemmfuß Pyramid | Wood Menu Holder Pyramid

- Holz Klemmfuß aus massivem Buchenholz, dunkel lasiert
 - Geeignet für Kreidetafel (beschreibbar und feucht oder nass abwischbar) oder Acryl Postertasche
 - Nut für 4 mm Einschub
- Wood base made of solid beech wood, dark glazed
 - Can be used with chalkboards (writable and moist or wet wipeable) or poster pocket
 - Groove for 4 mm insert

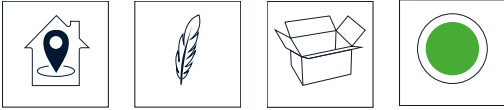

Art.-Nr.	Beschreibung	Format (mm)	VPE
UWCHPDO070X5000	Holz Klemmfuß Pyramid	70 mm	10
UWCHPDO105X5000	Holz Klemmfuß Pyramid	105 mm	10
UWCHPDO150X5000	Holz Klemmfuß Pyramid	150 mm	10
UWCHPDO210X5000	Holz Klemmfuß Pyramid	210 mm	10
1608009	Kreidetafel, 4 mm PVC	74 x 105	10
1608010	Kreidetafel, 4 mm PVC	105 x 148	10
1608011	Kreidetafel, 4 mm PVC	148 x 210	10
1608012	Kreidetafel, 4 mm PVC	210 x 297	10
UPCUAD00A6X2000	Acrylglastasche	105 x 148	10
UPCUAD00A5X2000	Acrylglastasche	148 x 210	10
UPCUAD00A4X2000	Acrylglastasche	210 x 297	10
9000014	Kreidestifte 8er Set		



Holz Klemmfuß DOUBLE | Wood Menu Holder DOUBLE

- Holz Klemmfuß aus massivem Buchenholz, dunkel lasiert
 - 90 oder 75 Grad Nut nutzbar
 - Geeignet für Kreidetafel (beschreibbar und feucht oder nass abwischbar) oder Acryl Postertasche
 - Nut für 4 mm Einschub
- Wood base made of solid beech wood, dark glazed
 - 90 or 75 degree groove
 - Can be used with chalkboards (writable and moist or wet wipeable) or poster pocket
 - Groove for 4 mm insert

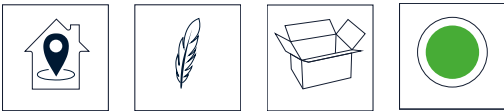

Art.-Nr.	Beschreibung	Format (mm)	VPE
UWCHODO070X5000	Holz Klemmfuß DOUBLE (mit 2 Nuten)	70 mm	10
UWCHODO105X5001	Holz Klemmfuß DOUBLE (mit 2 Nuten)	105 mm	10
UWCHODO150X5001	Holz Klemmfuß DOUBLE (mit 2 Nuten)	150 mm	10
UWCHODO210X5001	Holz Klemmfuß DOUBLE (mit 2 Nuten)	210 mm	10
1608009	Kreidetafel, 4 mm PVC	74 x 105	10
1608010	Kreidetafel, 4 mm PVC	105 x 148	10
1608011	Kreidetafel, 4 mm PVC	148 x 210	10
1608012	Kreidetafel, 4 mm PVC	210 x 297	10
UPCUAD00A6X2000	Acrylglastasche	105 x 148	10
UPCUAD00A5X2000	Acrylglastasche	148 x 210	10
UPCUAD00A4X2000	Acrylglastasche	210 x 297	10
9000014	Kreidestifte 8er Set		



Desktop Menüstander KONKAV | ARC Desktop Menu Holder

- Stilvoller Menüstander im geschwungenen Design
- Elegante Präsentation von Speisekarten oder Informationen
- Pulverbeschichtetes Stahlblech
- Einfacher Wechsel der Einleger durch Magnetfolie
- Erhältlich in DIN A4 Hoch- oder Querformat
- Silber oder schwarz

- *Stylish menu holder with curved design*
- *Elegant presentation of information*
- *Stable base made of powder-coated steel*
- *Easy change of graphic by magnetic poster cover*
- *Available in DIN A4 portrait or landscape*
- *Silver or black*

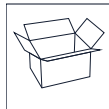

Art.-Nr.	Plakatmaß (mm)	Ausführung	Farbe	VPE
UMSAMP0GA4X2000	210 x 297	Hochformat	silber	2
UMSAMP0BA4X2000	210 x 297	Hochformat	schwarz	2
UMSAML0GA4X2000	297 x 210	Querformat	silber	2
UMSAML0BA4X2000	297 x 210	Querformat	schwarz	2

T-Aufsteller Swing Wing | T-Stand Swing Wing

- Eleganter Menükartenhalter mit Aluminium-Klemmfuß
- Er kann variabel Materialstärken zwischen 1 und 4 mm aufnehmen
- Neben Acryltaschen können auch andere Materialien wie PVC, PET oder PS als Info-Träger verwendet werden
- *Elegant menu card holder with silver anodised aluminium clamp base, that can take acrylic and other pockets*
- *Also it can hold different materials from up 1 mm to 4 mm thickness*

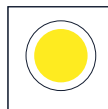
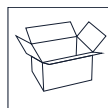

Art.-Nr.	Format hoch (mm)	Ausführung	VPE
USWMDNPA0A7X1000	74 x 105	Alu-Klemmfuß mit Acryl-Tasche	15
USWMDNPA43X1000	105 x 210	Alu-Klemmfuß mit Acryl-Tasche	30
USWMDNPA6X1000	105 x 148	Alu-Klemmfuß mit Acryl-Tasche	30
USWMDNPA5X1000	148 x 210	Alu-Klemmfuß mit Acryl-Tasche	25
USWMDNPA4X1000	210 x 297	Alu-Klemmfuß mit Acryl-Tasche	15
Art.-Nr.	Format quer (mm)	Ausführung	VPE
USWMYNPA7X1000	74 x 105	Alu-Klemmfuß mit Acryl-Tasche	10
USWMYNPA43X1000	105 x 210	Alu-Klemmfuß mit Acryl-Tasche	15
USWMYNPA6X1000	105 x 148	Alu-Klemmfuß mit Acryl-Tasche	25
USWMYNPA5X1000	148 x 210	Alu-Klemmfuß mit Acryl-Tasche	15
USWMYNPA4X1000	210 x 297	Alu-Klemmfuß mit Acryl-Tasche	10
Art.-Nr.	Format (mm)	Ausführung	VPE
USWMONP100X1000	100	Alu-Klemmfuß	12
USWMONP105X1000	105	Alu-Klemmfuß	12
USWMONP148X1000	148	Alu-Klemmfuß	6
USWMONP210X1000	210	Alu-Klemmfuß	28
USWMONP297X1000	297	Alu-Klemmfuß	20

Acryl T-Aufsteller | Clear Brochure Holder T-Type

- Glasklarer Acrylaufsteller in T-Form
- Hoch- oder Querformat
- Erhältlich in den Formaten DIN A6, DIN A5, DIN Lang, DIN A4

- Clear acrylic T-stand
- Portrait and landscape
- Available for DIN A6, DIN A5, 1/3 DIN A4 and DIN A4



DIN A5 Querformat



DIN A6 Querformat



DIN A6 Hochformat



DIN Lang Hochformat



DIN A4 Hochformat

Art.-Nr.	Format (mm)	Beschreibung	VPE
UMSTD01000X1100	210 x 297	A4 Hochformat	40
UMSTY01000X1100	297 x 210	A4 Querformat	30
UMSTD02000X1100	148 x 210	A5 Hochformat	30
UMSTY02000X1100	210 x 148	A5 Querformat	30
UMSTD03000X1100	105 x 148	A6 Hochformat	40
UMSTY03000X1100	148 x 105	A6 Querformat	30
UMSTD04000X1100	105 x 210	DIN Lang Hochformat	40
UMSTY04000X1100	210 x 105	DIN Lang Querformat	50

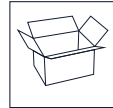

Acryl L-Aufsteller | Clear Brochure Holder L-Type

- Glasklarer Acrylaufsteller in L-Form
- Hoch- oder Querformat
- Erhältlich in den Formaten DIN A6, DIN A5, DIN Lang, DIN A4

- Clear acrylic L-stand
- Portrait and landscape
- Available for DIN A6, DIN A5, DIN A4 and 1/3 DIN A4



DIN A6 Querformat



DIN A5 Querformat



DIN A6 Hochformat



DIN A5 Hochformat

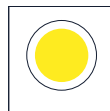
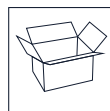

Art.-Nr.	Format (mm)	Beschreibung	VPE
UMSLD01000X1100	210 x 297	A4 Hochformat	40
UMSLY01000X1100	297 x 210	A4 Querformat	30
UMSLD02000X1100	148 x 210	A5 Hochformat	40
UMSLY02000X1100	210 x 148	A5 Querformat	30
UMSLD03000X1100	105 x 148	A6 Hochformat	30
UMSLY03000X1100	148 x 105	A6 Querformat	30
UMSLD04000X1100	105 x 210	DIN Lang Hochformat	65
UMSLY04000X1100	210 x 105	DIN Lang Querformat	50



DIN Lang Hochformat



DIN A4 Hochformat

NEU! Solar Drehteller | NEW! Solar Turntable

- Zuverlässiger Präsentations-Drehteller auf Standard-Sockel
 - Funktioniert bei Sonnen-, Halogen und Tageslicht
 - Zusätzlich kann eine AA Batterie eingesetzt werden
 - Dezente und edle Optik
 - Für die Präsentation von Uhren, Schmuck, Schreibgeräten, u.v.m.
 - Auch für die Warenpräsentation im Internet sehr gut geeignet
 - Drehteller Ø 60 mm, Tragkraft ca. 200 g
 - Weitere Größen auf Anfrage
-
- *Reliable presentation turntable on standard base*
 - *Works in sunlight, halogen and daylight*
 - *An AA battery can also be used*
 - *Discreet and noble optic*
 - *For the presentation of watches, jewellery, writing implements and much more*
 - *Also very suitable for the presentation of goods on the internet*
 - *Turntable Ø 60 mm, Capacity ~ 200 g*
 - *Special sizes on request*

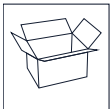

Art.-Nr.	Drehteller (mm)	Sockel (mm)
1508001	Ø 60	68 x 62 x 25

Magnet Posterrahmen | Magnetic Poster Frame

- Elegante Alternative zum klassischen Klapprahmen!
 - Moderner TFT-Look
 - Nur 12 mm Bautiefe
 - Einfacher Posterwechsel durch Magnettechnik mit Griffmulde
- *Stylish alternative to the classic snapframe*
 - *Modern flat screen-look*
 - *Only 12 mm depth*
 - *Practical magnetic protection cover for easy poster change*



ACHTUNG!
Für maximal 35°C Innentemperatur (einschließlich Sonneneinstrahlung) geeignet.
Es wird empfohlen, den Rahmen mindestens 30 cm vom Schaufenster entfernt zu montieren.
Aufgrund der Hitzeentwicklung (Sonneneinstrahlung) können Schäden an der Acrylscheibe entstehen.

ATTENTION:
35°C maximum indoor temperature (including daily sunny hours).
It should be assembled at least 30 cm from the window.
Heat (sunlight) can cause damage to the acrylic cover.

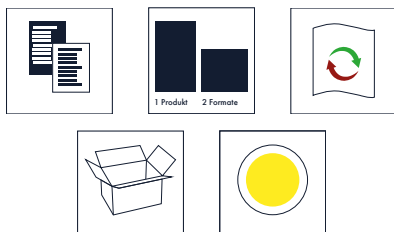

Art.-Nr.	Plakatmaß (mm)	Passepartout
UCMONTB0A4X2000	210 x 297	schwarz
UCMONTB0A3X2000	297 x 420	schwarz
UCMONTB0A2X2000	420 x 594	schwarz
UCMONTB0A1X2950	594 x 841	schwarz
UCMONTB0A0X2950	841 x 1189	schwarz
UCMONTB0B2X2000	500 x 700	schwarz
UCMONTB0B1X2000	700 x 1000	schwarz

Opti Frame Farbig | Opti Frame Colour

- Der patentierte Klapprahmen!
- Geeignet für INNENANWENDUNGEN
- 14mm Profil mit Safe Corner Ecke/Gehrung
- Vordere Plakatabdeckung aus entspiegeltem PET
- Farblich abgestimmte Rückwand aus Plastik
- Profile aus Alu
- Mit integrierter Rückenstütze (optional)
- Fünf Standardfarben (rot, blau, weiß, grün, gelb)
- Erhältlich in DIN A6 bis DIN A4

- *The patented snap frame!*
- *Suitable for INDOOR applications*
- *14 mm profile, safe corner/Mitred*
- *Anti-glare poster cover sheet*
- *Color-coordinated plastic back panel*
- *Aluminum profiles*
- *With integrated rear support (optional)*
- *Five standard colors (red, blue, white, green, yellow)*
- *Available in DIN A6 to DIN A4*



Art.-Nr.	Ausführung (mit Rückenstütze)	Format (DIN)
UCP145R1A6X1000	14 mm Gehrung, rot RAL 3020	A6
UCP145L1A6X1000	14 mm Gehrung, blau RAL 5002	A6
UCP145H1A6X1000	14 mm Gehrung, weiß RAL 9003	A6
UCP145E1A6X1000	14 mm Gehrung, grün RAL 6029	A6
UCP145Y1A6X2000	14 mm Gehrung, gelb RAL 1021	A6
UCP145R1A5X2000	14 mm Gehrung, rot RAL 3020	A5
UCP145L1A5X1000	14 mm Gehrung, blau RAL 5002	A5
UCP145H1A5X2000	14 mm Gehrung, weiß RAL 9003	A5
UCP145E1A5X1000	14 mm Gehrung, grün RAL 6029	A5
UCP145Y1A5X2000	14 mm Gehrung, gelb RAL 1021	A5



Art.-Nr.	Ausführung (mit Rückenstütze)	Format (DIN)
UCP145R1A4X1000	14 mm Gehrung, rot RAL 3020	A4
UCP145L1A4X1000	14 mm Gehrung, blau RAL 5002	A4
UCP145H1A4X1000	14 mm Gehrung, weiß RAL 9003	A4
UCP145E1A4X1000	14 mm Gehrung, grün RAL 6029	A4
UCP145Y1A4X1000	14 mm Gehrung, gelb RAL 1021	A4



Opti Frame Schwarz/Holz | Opti Frame Black/Wood Effect

- Der patentierte Klapprahmen!
- Geeignet für INNENANWENDUNGEN
- 25 mm Profil
- Safe Corner Ecke/Gehrung
- Schwarz pulverbeschichtet oder in Holz-Optik
- Vordere Plakatabdeckung aus entspiegeltem PET
- Farblich abgestimmte Rückwand aus Plastik
- Profile aus Alu
- Mit integrierter Rückenstütze (optional)

- *The patented snap frame!*
- *Suitable for INDOOR applications*
- *25 mm profile*
- *Safe corner/Mitred*
- *The front profiles are powder-coated in black or wood effect finish*
- *Anti-glare poster cover sheet*
- *Color-coordinated plastic back panel*
- *Aluminum profiles*
- *With integrated rear support (optional)*

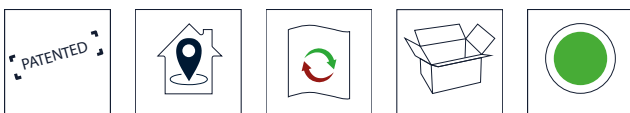

Art.-Nr.	Plakatmaß (mm)	Farbe	Beschreibung
UCP255B1A4X1000	210 x 297	schwarz	mit Rückenstütze
UCP255B0A4X1000	210 x 297	schwarz	ohne Rückenstütze
UCP255W1A4X1000	210 x 297	Holz-Optik	mit Rückenstütze
UCP255W0A4X1000	210 x 297	Holz-Optik	ohne Rückenstütze



Opti Frame | Opti Frame

- Der patentierte Klapprahmen!
- Geeignet für INNENANWENDUNGEN
- 25 mm Profil
- Safe Corner Ecke/Gehrung oder Rondo
- Vordere Plakatabdeckung aus entspiegeltem PET
- Rückwand aus Plastik
- Profile aus Alu
- Mit Rückenstütze nutzbar als Fotorahmen (optional)
- Für A4-, A3- und A2-Plakate geeignet, keine Sonderformate möglich!

Opti®
Frame

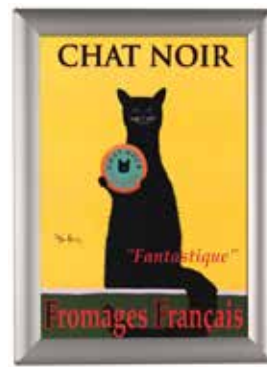

- The patented snap frame!
- Suitable for INDOOR applications
- 25 mm profile, safe corner/Mitred or Rounded
- Anti-glare poster cover sheet
- Plastic back panel
- Aluminum profiles
- With rear support for desktop application
- Suitable for A4, A3 and A2 posters, no special formats possible!



Art.-Nr. Gehrung	Art.-Nr. Rondo	Plakatmaß (mm)	Beschreibung
UCP255N0A4X1000	UCP250N0A4X1000	210 x 297	Opti Frame ohne Rückenstütze
UCP255N1A4X1000	UCP250N1A4X1000	210 x 297	Opti Frame mit Rückenstütze
UCP255N0A3X1000	UCP250N0A3X1000	297 x 420	Opti Frame ohne Rückenstütze
UCP255N0A2X1000		420 x 594	Opti Frame ohne Rückenstütze

Klapprahmen BASIC Frame | BASIC Frame

- Der patentierte Economy Klapprahmen im 10er Vorteilspack
- 25 mm Profil, Safe Corner Ecke, Gehrung
- Rückwand aus Plastik
- Profile aus Alu
- Vordere Plakatabdeckung aus entspiegeltem PET
- Geeignet zur Wandmontage
- Geeignet für INNENANWENDUNGEN
- Erhältlich in DIN A4 und DIN A3, keine Sonderformate möglich!

- The patented economy snap frame packed by 10 pc. discount pack
- 25 mm profile, Safe corner version, Mitred
- Plastic back panel
- Aluminum profiles
- Anti-glare poster cover sheet
- Suitable for wall mounting
- Suitable for INDOOR applications
- Available in DIN A4 and DIN A3, no special formats possible!



Art.-Nr.	Produkt	Farbe	Plakatmaß (mm)	Menge
1101054	Basic - 25 mm Klapprahmen	silber	210 x 297	10
1101055	Basic - 25 mm Klapprahmen	silber	210 x 297	50
1101056	Basic - 25 mm Klapprahmen	silber	210 x 297	100
1101204	Basic - 25 mm Klapprahmen	silber	297 x 420	10
1101212	Basic - 25 mm Klapprahmen	silber	297 x 420	30
1101213	Basic - 25 mm Klapprahmen	silber	297 x 420	120
1101200	Basic - 25 mm Klapprahmen	schwarz	210 x 297	10
1101201	Basic - 25 mm Klapprahmen	schwarz	210 x 297	50
1101202	Basic - 25 mm Klapprahmen	schwarz	210 x 297	100
1101208	Basic - 25 mm Klapprahmen	schwarz	297 x 420	10
1101214	Basic - 25 mm Klapprahmen	schwarz	297 x 420	30
1101215	Basic - 25 mm Klapprahmen	schwarz	297 x 420	120

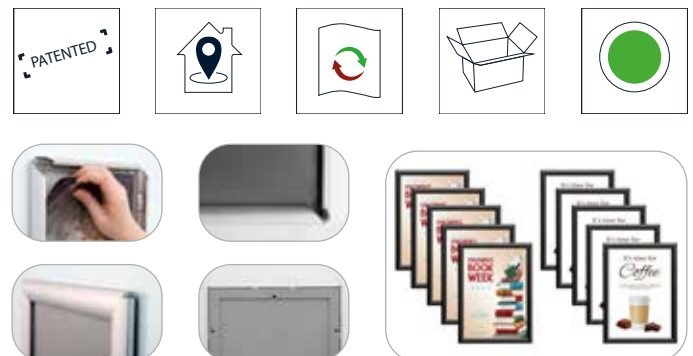

Klapprahmen 15/20/25/32 mm | Snap Frame 15/20/25/32 mm

- Ideal für alle Posterformate!
- Geeignet für INNENANWENDUNGEN
- Profil 15, 20, 25 und 32 mm
- Ecke/Gehrung oder Rondo
- Oberprofile silber eloxiert
- Rückwand aus Polystyrol
- Vordere Plakatabdeckung aus entspiegeltem PET
- Sondermaße und RAL Farben auf Anfrage

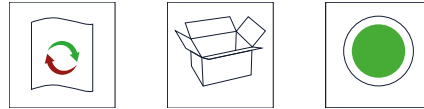

- Ideal for all poster sizes!
- Suitable for INDOOR applications
- Profiles 15, 20, 25 and 32mm
- Mitred or rounded corner
- Top profiles silver anodised
- Backing made of polystyrene
- Front poster cover made of non-reflective PET
- Special dimensions and RAL colors on request



15 mm Klapprahmen, Gehrung
15 mm Snap frame, mitred



Version Gehrung
Mitred Version



25 mm Klapprahmen, Rondo
25 mm Snap frame, rounded



20 mm Klapprahmen, Gehrung
20 mm Snap frame, mitred



Version Rondo
Rounded version



32 mm Klapprahmen, Rondo
32 mm Snap frame, rounded



32 mm Klapprahmen, Gehrung
32 mm Snap frame, mitred

Art.-Nr. Gehrung	Art.-Nr. Rondo	Profil (mm)	Plakatmaß (mm)
UCN155NOA5X1000	-	15	148 x 210
UCN155NOA4X1000	-	15	210 x 297
UCN155NOA3X1000	-	15	297 x 420
UCN155NOA2X1000	-	15	420 x 594
UCN155NOA1X2950	-	15	594 x 841
UCN155NOB2X1000	-	15	500 x 700
UCN155NOB1X1000	-	15	700 x 1000
UCN205NOA4X1000	-	20	210 x 297
UCN205NOA3X1000	-	20	297 x 420
UCN205NOA2X1000	-	20	420 x 594
UCN205NOA1X2950	-	20	594 x 841
UCN205NOB2X1000	-	20	500 x 700
UCN205NOB1X1000	-	20	700 x 1000
UCN255NOA4X1000	UCN250NOA4X1000	25	210 x 297
UCN255NOA3X1000	UCN250NOA3X1000	25	297 x 420
UCN255NOA2X1000	UCN250NOA2X1000	25	420 x 594
UCN255NOA1X2950	UCN250NOA1X2950	25	594 x 841
UCN255NOA0X2950	UCN250NOA0X2950	25	841 x 1189
UCN255NOB2X1000	UCN250NOB2X1000	25	500 x 700
UCN255NOB1X1000	UCN250NOB1X1000	25	700 x 1000
UCN325NOA3X1000	UCN320NOA3X1000	32	297 x 420
UCN325NOA2X1000	UCN320NOA2X1000	32	420 x 594
UCN325NOA1X2950	UCN320NOA1X2950	32	594 x 841
UCN325NOA0X2950	UCN320NOA0X2950	32	841 x 1189
UCN325NOB2X1000	UCN320NOB2X1000	32	500 x 700
UCN325NOB1X1000	UCN320NOB1X1000	32	700 x 1000
UCN325NOB0X1000	UCN320NOB0X1000	32	1000 x 1400

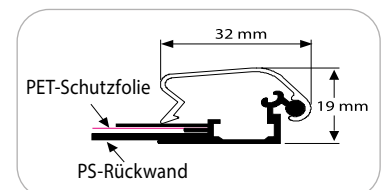
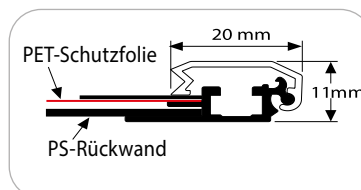
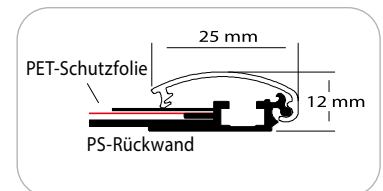
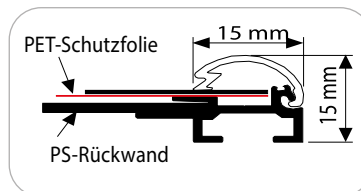

Klapprahmen 25 mm Schwarz, Holz oder RAL | Snap Frame 25 mm black powder-coated, Wood Look Effect or RAL

- Exklusiver Rahmen in unterschiedlicher Farbgestaltung
 - Geeignet für INNENANWENDUNGEN
 - Profil 25 mm
 - Ecken auf Gehrung
 - Vordere Plakatabdeckung aus entspiegeltem PET
 - Ideal für Posterformat DIN A4 bis DIN A0
 - Sondermaße auf Anfrage
-
- *The bestseller with various finishes*
 - *Suitable for INDOOR applications*
 - *25 mm profile*
 - *Mitred corners*
 - *Front poster cover made of non-reflective PET*
 - *Ideal for postersize DIN A4 to DIN A0*
 - *Special dimensions on request*



Holz-Optik / Wood effect

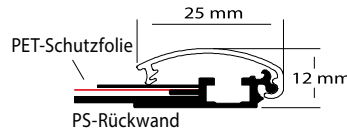
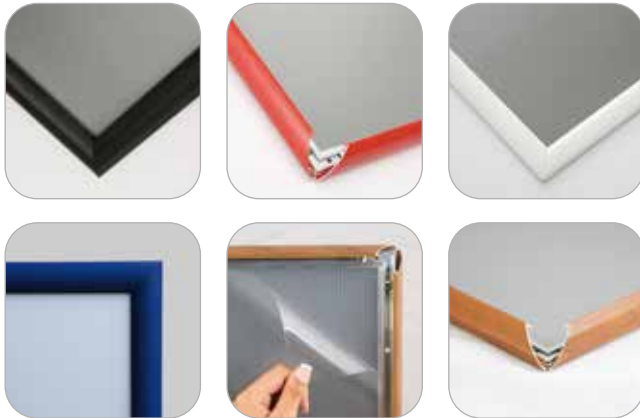

Art.-Nr.	Farbe	Plakatmaß (mm)
UCN25510A4X2000	schwarz RAL 9005	210 x 297
UCN25510A3X2000	schwarz RAL 9005	297 x 420
UCN25510A2X2000	schwarz RAL 9005	420 x 594
UCN25510A1X2950	schwarz RAL 9005	594 x 841
UCN25510A0X2950	schwarz RAL 9005	841 x 1189
UCN25510B2X2000	schwarz RAL 9005	500 x 700
UCN25510B1X2000	schwarz RAL 9005	700 x 1000
UCN255W0A4X1000	Holz Optik	210 x 297
UCN255W0A3X1000	Holz Optik	297 x 420
UCN255W0A2X1000	Holz Optik	420 x 594
UCN255W0A1X2950	Holz Optik	594 x 841
UCN255W0A0X2950	Holz Optik	841 x 1189
UCN255W0B2X1000	Holz Optik	500 x 700
UCN255W0B1X1000	Holz Optik	700 x 1000
UCN25520A4X2000	weiß RAL 9003	210 x 297
UCN25520A3X2000	weiß RAL 9003	297 x 420
UCN25520A2X2000	weiß RAL 9003	420 x 594
UCN25520A1X2950	weiß RAL 9003	594 x 841
UCN25520A0X2950	weiß RAL 9003	841 x 1189
UCN25520B2X2000	weiß RAL 9003	500 x 700
UCN25520B1X2000	weiß RAL 9003	700 x 1000
UCN255C0A4X5024	blau RAL 5002	210 x 297
UCN255C0A3X5024	blau RAL 5002	297 x 420
UCN255C0A2X5141	blau RAL 5002	420 x 594
UCN255C0A1X5114	blau RAL 5002	594 x 841
UCN255C0A0X5020	blau RAL 5002	841 x 1189
UCN255C0B2X5037	blau RAL 5002	500 x 700
UCN255C0B1X5043	blau RAL 5002	700 x 1000
UCN25530A4X2000	rot RAL 3020	210 x 297
UCN25530A3X2000	rot RAL 3020	297 x 420
UCN25530A2X2000	rot RAL 3020	420 x 594
UCN25530A1X2950	rot RAL 3020	594 x 841
UCN25530A0X2950	rot RAL 3020	841 x 1189
UCN25530B2X2000	rot RAL 3020	500 x 700
UCN25530B1X2000	rot RAL 3020	700 x 1000

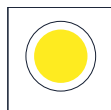
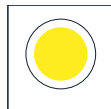
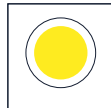
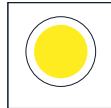

Weiß RAL 9003 / White RAL 9003



RAL 9005 schwarz / RAL 9005 black



Blau RAL 5002 / Blue RAL 5002

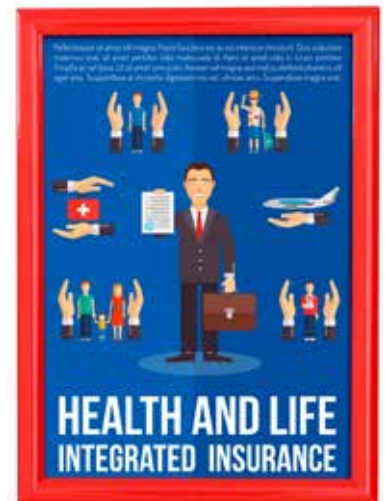

Rot RAL 3020 / Red RAL 3020

Klapprahmen FireProtection | Snap Frame FireProtection

- Klapprahmen für den Einsatz in öffentlichen Räumen
 - Schutzfolie aus B1 zertifiziertem PET
 - Geeignet für INNENANWENDUNGEN
 - Profil 25 mm, silber eloxiert mit Gehrungsecken
 - Brandklassifizierung nach EN13501-1 Klasse B s1 d0, schwer entflammbar
 - Rückwand aus Metall
 - Sondermaße auf Anfrage
- *Snapframe for public buildings*
 - *Cover sheet with B1 certification*
 - *Suitable for INDOOR applications*
 - *25mm silver anodised profile with mitred corners*
 - *Fire classified for EN13501-1 Class B s1 d0, hardly inflammable*
 - *Metall backing*
 - *Special dimensions on request*



Art.-Nr.	Plakatmaß (mm)	Farbe
UCFR255NA4X2000	210 x 297	silber eloxiert
UCFR255NA3X2000	297 x 420	silber eloxiert
UCFR255NA2X2000	420 x 594	silber eloxiert
UCFR255NA1X2950	594 x 841	silber eloxiert
UCFR255NA0X2950	841 x 1189	silber eloxiert
UCFR255NB2X2000	500 x 700	silber eloxiert
UCFR255NB1X2000	700 x 1000	silber eloxiert



Doppelseitiger Klapprahmen | Double-sided Snap Frame

- 25 mm Profil / Gehrung
 - Ideal für Schaufensterwerbung oder Ladengestaltung
 - Ecken auf Gehrung
 - Nutzbar im Hoch- oder Querformat
 - Deckenabhängige-Set als Zubehör erhältlich
- *25 mm Profile / Mitred*
 - *Ideal for shop window or store*
 - *Mitred corners*
 - *Can be used in portrait or landscape format*
 - *Ceiling suspension set must be ordered separately*

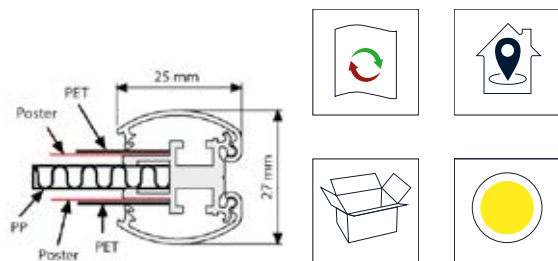

Art.-Nr.	Plakatmaß (mm)	Ausführung
UCD255N3A3X5001	297 x 420	Hoch- und Querformat
UCD255N3A2X5001	420 x 594	Hoch- und Querformat
UCD255N3A1X5001	594 x 841	Hoch- und Querformat
Art.-Nr.	Beschreibung	
2100005	Seilset	



Safety-Klapprahmen | Security Frame

- 25 mm Profil / Gehrung Safety
- Sicherheitsprofil ohne Griffmulde
- Spezialhebel für Profillöpfung erforderlich
- Ideal für öffentliche Räume
- Profillöfner als Zubehör erhältlich

- 25 mm Profile / Mitred Security
- Suitable for public areas
- Snap profile without grip
- Frame can be opened with lever tool
- Lever tool must be ordered separately

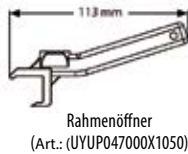
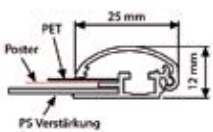
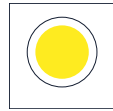
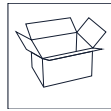

Art.-Nr.	Plakatmaß (mm)
UCZ255N0A4X1000	210 x 297
UCZ255N0A3X1000	297 x 420
UCZ255N0A2X1000	420 x 594
UCZ255N0A1X1000	594 x 841
UCZ255N0B2X1000	500 x 700
Art.-Nr.	Bezeichnung
UYUP047000X1050	Rahmenöffner 25/32



Klapprahmen HardLine, 33 mm, Gehrung | Snap Frame HardLine, 33 mm, mitred

- Neuer Design Klapprahmen in kantiger Optik
- Schwarze oder silberfarbige Klemmprofile
- Klares, flaches Profildesign
- Ideal geeignet bis Posterformat DIN A0
- Auf Anfrage auch erhältlich als ein- oder doppelseitiger LED Leuchtraumen

- New design Snap frame in an edgy look
- Black or silver snap profiles
- Clear, flat look
- Ideally suited to poster size DIN A0
- On request also available as single or double sided LED snapframe

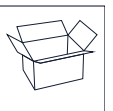
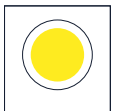

Art.-Nr.	Farbe	Plakatmaß (mm)
UCN33510A4X5000	Schwarz	210 x 297
UCN33510A3X5000	Schwarz	297 x 420
UCN33510A2X5000	Schwarz	420 x 594
UCN33510A1X5000	Schwarz	594 x 841
UCN33510A0X5000	Schwarz	841 x 1189
UCN33510B2X5000	Schwarz	500 x 700
UCN33510B1X5000	Schwarz	700 x 1000
UCN335N0A4X5000	Silber eloxiert	210 x 297
UCN335N0A3X5000	Silber eloxiert	297 x 420
UCN335N0A2X5000	Silber eloxiert	420 x 594
UCN335N0A1X5000	Silber eloxiert	594 x 841
UCN335N0A0X5000	Silber eloxiert	841 x 1189
UCN335N0B2X5000	Silber eloxiert	500 x 700
UCN335N0B1X5000	Silber eloxiert	700 x 1000



Fenster-Klapprahmen | Window Frame

- 25 mm Profil / Gehrung
- Poster sind auf beiden Seiten des Schaufensters sichtbar
- Mit Spiegelklebeband konfektioniert für die Montage auf Glas
- Plakatwechsel erfolgt von innen
- Konterrahmen als Blende für Außen

- 25 mm Profile / Mitred
- Posters are visible in – and outdoor
- Comes with double sided tape
- Poster change indoor
- Decorative cover frame for outdoor

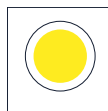
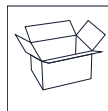
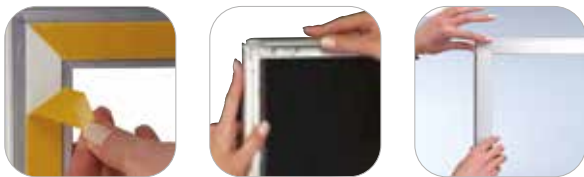

Art.-Nr.	Plakatmaß (mm)
UCW255N4A4X1000	210 x 297
UCW255N4A3X1000	297 x 420
UCW255N4A2X1000	420 x 594
UCW255N4A1X2950	594 x 841
UCW255N4B2X1000	500 x 700
UCW255N4B1X1000	700 x 1000

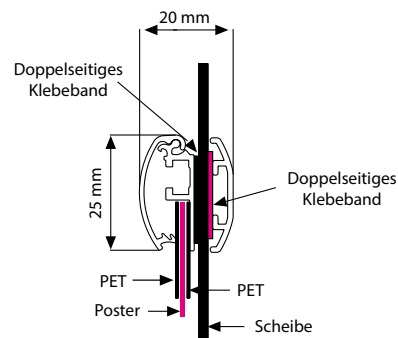

Fenster-Klapprahmen HardLine | Window Frame HardLine

- Ideal für größere Formate
- 33 mm Profil in modernem, kantigem Profildesign, RAL 9005
- Poster sind auf beiden Seiten des Schaufensters sichtbar
- Schwarzes Acrylat-Klebeband erzeugt einen Rahmen-Look auch auf der Außenseite des Fensters
- OHNE Konterrahmen

- Ideal for large poster sizes
- 33 mm profile in modern, square profile design, RAL 9005
- Posters are visible on both sides of the shop window
- Black acrylic tape creates a frame look on the outside of the window
- Comes WITHOUT counter frame



Art.-Nr.	Farbe	Plakatmaß (mm)
UCW33510A4X2000	Schwarz	210 x 297
UCW33510A3X2000	Schwarz	297 x 420
UCW33510A2X2000	Schwarz	420 x 594
UCW33510A1X2000	Schwarz	594 x 841
UCW33510A0X2000	Schwarz	841 x 1189
UCW33510B2X2000	Schwarz	500 x 700
UCW33510B1X2000	Schwarz	700 x 1000
UCW335N0A4X2000	Silber eloxiert	210 x 297
UCW335N0A3X2000	Silber eloxiert	297 x 420
UCW335N0A2X2000	Silber eloxiert	420 x 594
UCW335N0A1X2000	Silber eloxiert	594 x 841
UCW335N0A0X2000	Silber eloxiert	841 x 1189
UCW335N0B2X2000	Silber eloxiert	500 x 700
UCW335N0B1X2000	Silber eloxiert	700 x 1000



Wasserfester Klapprahmen | Waterproof Snap Frame



- Perfekt für den Außeneinsatz
- 25 mm Profil
- Ecken auf Gehrung
- Umlaufende Dichtung auf dem Unterprofil
- Übergroße Schutzfolie
- Wasserablauföffnungen verhindern Staunässe

- *Perfect for outdoor use*
- *25 mm Profile*
- *Mitred corners*
- *Sealing on backprofile*
- *Oversize cover sheet*
- *Water drainage holes avoid moisture*



Art.-Nr.	Plakatmaß (mm)	Farbe
UCH255NOA4X1000	210 x 297	silber
UCH255NOA3X1000	297 x 420	silber
UCH255NOA2X1000	420 x 594	silber
UCH255NOA1X2950	594 x 841	silber
UCH255NOA0X2950	841 x 1189	silber
UCH255NOB2X1000	500 x 700	silber
UCH255NOB1X1000	700 x 1000	silber
UCH255COA4X5001	210 x 297	schwarz
UCH255COA3X5011	297 x 420	schwarz
UCH255COA2X5000	420 x 594	schwarz
UCH255COA1X5003	594 x 841	schwarz
UCH255COA0X5002	841 x 1189	schwarz
UCH255COB2X5006	500 x 700	schwarz
UCH255COB1X5001	700 x 1000	schwarz

Wasserfester Klapprahmen mit Sicherungsschraube | Lockable Waterproof Snap Frame



- 35 mm Profil / Gehrung
- Geeignet für Außeneinsatz
- Sicherung des Rahmens durch Inbusschraube und Metallecken
- Umlaufende Dichtung auf dem Unterprofil
- Übergroße Schutzfolie
- Wasserablauföffnungen verhindern Staunässe

- *35 mm Profile / Mitred*
- *Suitable for outdoor use*
- *Profiles open sequentially*
- *Last profile is secured by allen screw*
- *Sealing on backprofile*
- *Oversize cover sheet*
- *Water drainage holes avoid moisture*

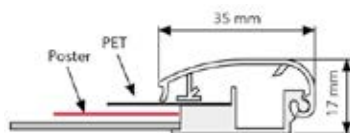
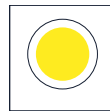

Art.-Nr.	Plakatmaß (mm)
UCV355NOA3X1000	297 x 420
UCV355NOA2X1000	420 x 594
UCV355NOA1X2950	594 x 841
UCV355NOA0X2950	841 x 1189
UCV355NOB2X1000	500 x 700
UCV355NOB1X1000	700 x 1000
UCV355NOBOX1000	1000 x 1400



Easy-Fix Klapprahmen | *Double sided tape snapframe*

- Auspacken, ankleben - Plakat einlegen - fertig!
- 25 mm Profil / Gehung
- Ideal für alle glatten Flächen
- Sekundenschnelle Montage ohne Werkzeug
- Sicherer Halt dank hochwertigem Spiegel-Klebeband
- Geeignet für INNENANWENDUNGEN

- *Unpack - stick on - insert the poster - done!*
- *Profile 25 mm / Mitred corners*
- *Ideal for all even surfaces*
- *Easy and toolless fixation*
- *Secure attachment thanks to rear double sided tape*
- *Suitable for INDOOR applications*

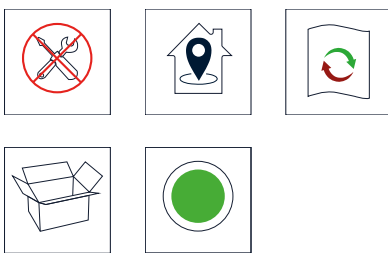

Art.-Nr.	Plakatmaß (mm)	Farbe
UCN255NOA4X5038	210 x 297	silber
UCN255NOA3X5076	297 x 420	silber
UCN255NOA2X5047	420 x 594	silber
UCN255NOA1X5042	594 x 841	silber
UCN255NOA0X5626	841 x 1189	silber
UCN255NOB2X5022	500 x 700	silber
UCN255NOB1X5017	700 x 1000	silber
UCN255COA4X5078	210 x 297	schwarz
UCN255COA3X5178	297 x 420	schwarz
UCN255COA2X5109	420 x 594	schwarz
UCN255COA1X5142	594 x 841	schwarz
UCN255COA0X5032	841 x 1189	schwarz
UCN255COB2X5079	500 x 700	schwarz
UCN255COB1X5045	700 x 1000	schwarz



Laternen Klapprahmen | Lantern Frame

- Klapprahmen im Hochformat für die Parkplatz- und Veranstaltungswerbung
 - 25 mm Profil
 - Wasserfeste Ausführung mit umlaufendem Dichtgummi
 - Einfache Montage durch 2 Universalschellen
 - Einzelverpackt im Karton
- *Snapframe for parking and event advertising*
 - *25 mm profile*
 - *Waterproof version with sealing on rear profile*
 - *Easy mounting thanks to 2 universal clamps*
 - *Comes in individual carton*

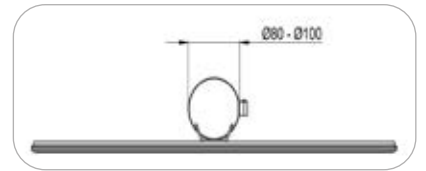
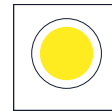
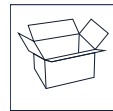

Art.-Nr.	Ausführung	Plakatformat (mm)
UCH255N0A2X5005	mit Universalschelle	420 x 594
UCH255N0A1X5005	mit Universalschelle	594 x 841

Poster-Klemmleiste WOOD | Poster Snap WOOD

- Stilvolle Poster-Präsentation bestehend aus zwei Leisten aus massivem Buchenholz, dunkel lasiert
 - Feste Klemmung durch eingesenkte Power-Magnete
 - Einfache Aufhängung dank mitgelieferter Hanf Schnur
- *Stylish poster presentation consisting of two rails of solid beech wood, dark glazed*
 - *Strong clamping through recessed power magnets*
 - *Easy hanging thanks to the included natural rope*

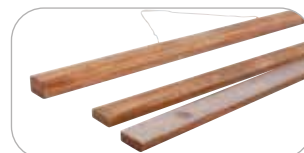
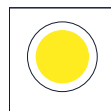
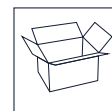
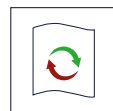

Art.-Nr.	Länge (mm)
UPTWOSD300X2000	300
UPTWOSD400X2000	400
UPTWOSD500X2000	500
UPTWOSD600X2000	600

Poster-Klemmleiste Snap | Poster Snap

- Die preiswerte Lösung für die Plakat- oder Bannerwerbung
 - Set bestehend aus 2 Klemmleisten
 - Verschiebbare Aufhänger an der oberen Leiste
 - Eingeklebtes Anti-Rutsch Gummi
- *Competitive solution for poster or banner advertising*
 - *Set of 2 snap-rails*
 - *Moveable hooks on top-rail*
 - *Poster clamps with extra wide surface prevent the posters from tearing out*

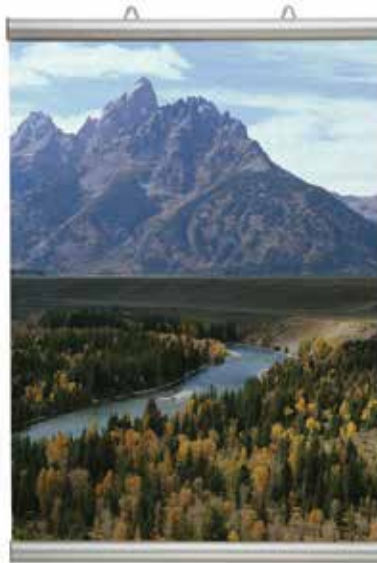
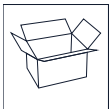

Art.-Nr.	Länge (mm)	Farbe	Beschreibung
UPT26SN030X1000	300	silbern eloxiert	26 mm Profil, Set
UPT26SN042X1000	420	silbern eloxiert	26 mm Profil, Set
UPT26SN050X1000	500	silbern eloxiert	26 mm Profil, Set
UPT26SN060X1000	600	silbern eloxiert	26 mm Profil, Set
UPT26SN070X1000	700	silbern eloxiert	26 mm Profil, Set
UPT26SN085X1000	850	silbern eloxiert	26 mm Profil, Set
UPT26SN100X1000	1000	silbern eloxiert	26 mm Profil, Set
Art.-Nr.	Beschreibung		
2100001	Drahtseil- Abhängeset		

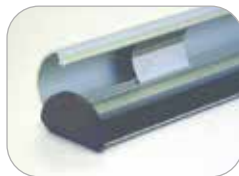

Poster-Klemmleiste Clamp | Poster Clamp

- Ideale Lösung für große Banner
 - Set bestehend aus 2 Klemmleisten
 - Verschiebbare Aufhänger an der oberen Leiste
 - Hohe Klemmwirkung durch Exzenter-Prinzip
- *Ideal solution for large banner advertising*
 - *Set of 2 clamp-rails*
 - *Moveable hooks on top-rail*
 - *High grip thanks to eccentric clamp*

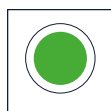
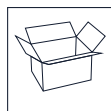
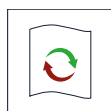
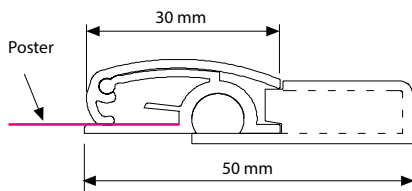

Art.-Nr.	Länge (mm)
UPC00SN021X1000	210
UPC00SN030X1000	300
UPC00SN042X1000	420
UPC00SN050X1000	500
UPC00SN060X1000	600
UPC00SN070X1000	700
UPC00SN085X1000	850
UPC00SN100X1000	1000
Art.-Nr.	Beschreibung
2100001	Drahtseil- Abhängeset



Einschubrahmen als Info-Topper | Counter Slide-in Frame



- Desktop Posterrahmen für In- und Outdoor
 - Einfache Montage von Standfuß durch doppelseitiges Klebeband
 - Wetterfest durch Dichtgummi auf der Einschubseite
 - Ideal geeignet für den Einsatz auf Zapfsäulen, Theken oder Regalen
- Desktop poster frame for in- and outdoor use
 - Easy mounting thanks to feet with double-sided tape
 - Weatherproof thanks to sealing at slide-in opening
 - Ideally suited for application on pumps, counters or shelves

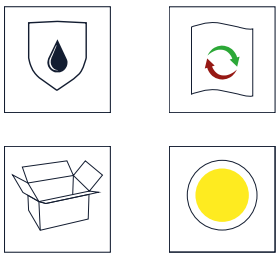

Art.-Nr.	Plakatmaß (mm)
UCA255N2A4X1000	210 x 297
UCA255N2A3X1000	297 x 420



Spannrahmen | Stretch Frame

- Federleichter Poster-Rahmen
 - Filigranes Aluminium Profil mit steckbaren Eckverbindern
 - Verschiebbare Aufhänger erlauben Hoch- oder Querformat
 - Plakatklammern mit extra breiter Auflagefläche verhindern Ausreißen der Plakate
- Lightweight poster frame
 - Filigree aluminum profile with plug-in corner connectors
 - Moveable hooks allow portrait or landscape application
 - Poster clamps with extra wide surface prevent the posters from tearing out

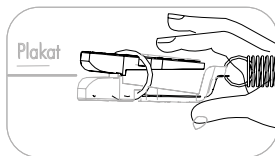

Art.-Nr.	Plakatmaß (mm)
UPSCN000A4X5008	210 x 297
UPSCN000A3X5004	297 x 420
UPSCN000A2X5002	420 x 594
UPSCN000A1X5005	594 x 841
Art.-Nr.	Beschreibung
2100039	Nylon-Seilset



LED Leuchtrahmen 25 mm, einseitig, Economy | LED lightframe 25 mm, single-sided, Economy

- Einseitig beleuchteter Klapprahmen für schnellen Motivwechsel
- Bautiefe 18 mm, Profilbreite 25 mm
- Farbtemperatur 5600-6500 K
- Ausleuchtung durch LED-Flächenlicht
- Sondermaße bis zu 800 x 1200 mm möglich

- Single-sided illuminated snapframe for a quick change of poster
- Construction depth 18 mm, profile width 25 mm
- Color temperature 5600-6500 K
- Illumination by LED LGP
- Special dimensions up to 800 x 1200 mm possible

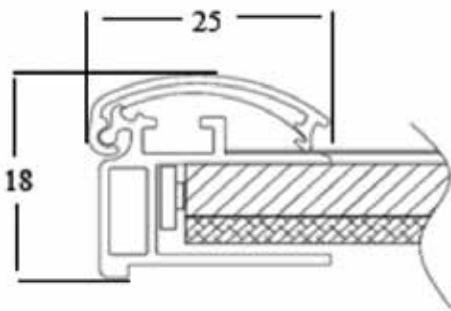
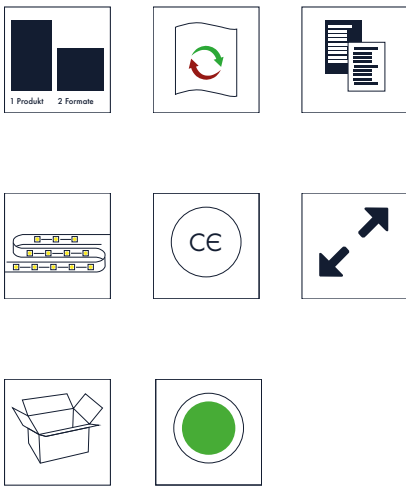

Art.-Nr.	Plakatmaß (mm)	Profilbreite (mm)	Farbe	Ausleuchtung (Lux)	Watt
ULB25TNOA3X2000	297 x 420	25	silber	3000	14
ULB25TNOA2X2000	420 x 594	25	silber	2700	20
ULB25TNOA1X2000	594 x 841	25	silber	2100	28,5
ULB25TNOA0X2000	841 x 1189	25	silber	1800	40,5
ULB25TNOB2X2000	500 x 700	25	silber	2400	24
ULB25TNOB1X2000	700 x 1000	25	silber	2000	35
ULB25TBOA3X2000	297 x 420	25	schwarz	3000	14
ULB25TBOA2X2000	420 x 594	25	schwarz	2700	20
ULB25TBOA1X2000	594 x 841	25	schwarz	2100	28,5
ULB25TBOA0X2000	841 x 1189	25	schwarz	1800	40,5
ULB25TBOB2X2000	500 x 700	25	schwarz	2400	24
ULB25TBOB1X2000	700 x 1000	25	schwarz	2000	35

LED Leuchtrahmen 25 mm, doppelseitig, Economy | LED lightframe 25 mm, double-sided, Economy



- Doppelseitig beleuchteter Klapprahmen für schnellen Motivwechsel
- Bautiefe 30 mm, Profildbreite 25 mm
- Ausleuchtung durch LED-Flächenlicht
- Farbtemperatur 5600-6500 K
- Seilabhängung für Hoch- oder Querformat
- Sondermaße bis zu 800 x 1200 mm möglich

- Double-sided illuminated snapframe for a quick change of poster
- Construction depth 30 mm, profile width 25 mm
- Color temperature 5600-6500 K
- Illumination by LED LGP
- Suspension wire set for portrait and landscape application
- Special dimensions up to 800 x 1200 mm possible

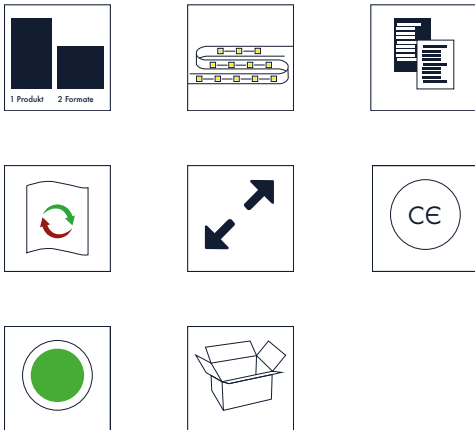
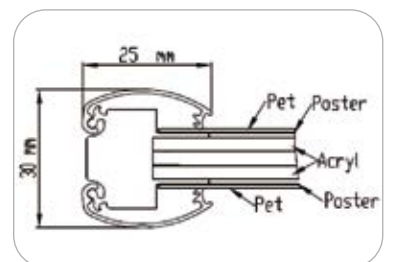

Art.-Nr.	Plakatmaß (mm)	Ausleuchtung (Lux)	Watt	Farbe
ULB25CNOA3X2000	297 x 420	2600	14	silber
ULB25CNOA2X2000	420 x 594	2300	20	silber
ULB25CNOA1X1000	594 x 841	2000	28,5	silber
ULB25CNOA0X1000	841 x 1189	1400	40,5	silber
ULB25CN0B2X2000	500 x 700	2200	24	silber
ULB25CN0B1X2000	700 x 1000	1800	35	silber
ULB25CBOA1X2000	594 x 841	2000	28,5	schwarz

LED Leuchtrahmen 25/35 mm, einseitig | LED lightframe 25/35 mm single-sided

- Einseitig beleuchtetes Display mit Klemmprofilen für schnellen Motivwechsel
 - Bautiefe 19 mm, Profilbreite 25 mm
 - Farbtemperatur 5600-6500 K
 - Ausleuchtung durch Flächenlicht
 - Ein-/Aus-Schalter am Rahmen und steckbares Netzteil
 - Sondermaße bis zu 1200 x 2415 mm möglich
 - **LED können getauscht werden**
- *Single-sided illuminated display with snap profiles for an easy change of graphic*
 - *Depth 19 mm, snap profile 25 mm*
 - *Color temperature 5600 - 6500 K*
 - *Illumination by LGP*
 - *On / off switch on the frame and pluggable power supply*
 - *Special dimensions up to 1200 x 2415 mm available*
 - **LED can be replaced**

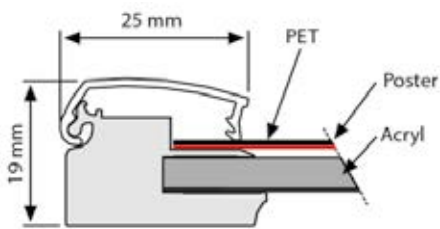
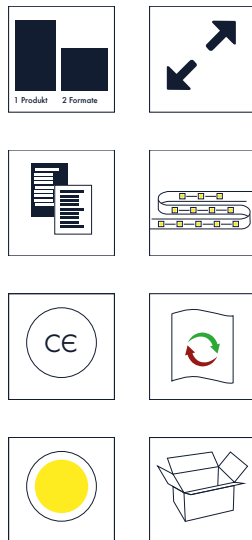

Art.-Nr.	Plakatmaß (mm)	Profilbreite (mm)	Bautiefe (mm)	Ausleuchtung (Lux)	Watt
ULD25TNOA4X1000	210 x 297	25	19	2000	6
ULD25TNOA3X1000	297 x 420	25	19	3300	18
ULD25TNOA2X1000	420 x 594	25	19	3300	23
ULD25TNOA1X1000	594 x 841	25	19	3000	35
ULD25TNOA0X1000	841 x 1189	25	19	2700	48
ULD25TNOB2X1000	500 x 700	25	19	3200	27
ULD25TNOB1X1000	700 x 1000	25	19	2800	41
ULD35TNOB0X1000	1000 x 1400	35	29	2300	58

LED Magnetrahmen Economy, einseitig | LED Magnetic Frame Economy, single-sided



- LED Leuchtrahmen im TFT Look
- Superflache Bautiefe von nur 13 mm!
- Homogene und brillante Ausleuchtung
- Bewährtes LED-Flächenlicht
- Einfacher Posterwechsel durch Magnettechnik mit Griffmulde
- *Eye-catching, illuminated presentation in TFT look*
- *Very slim- depths only 13 mm!*
- *Practical magnetic protection cover for easy poster change*
- *Finger hole to push cover*
- *High and even illumination by LGP*

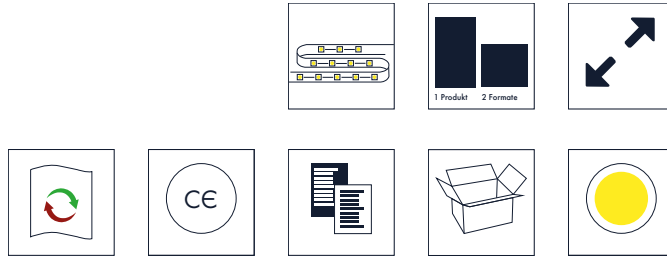

Art.-Nr.	Plakatmaß (mm)	Ausleuchtung (Lux)	Watt
ULDMENOA4X2000	210 x 297	3600	12
ULDMENOA3X2000	297 x 420	3300	18
ULDMENOA2X2000	420 x 594	3000	23
ULDMENOA1X2000	594 x 841	2600	35
ULDMENOA0X2000	841 x 1189	1800	48
ULDMENOB2X2000	500 x 700	2500	27
ULDMENOB1X2000	700 x 1000	2100	41

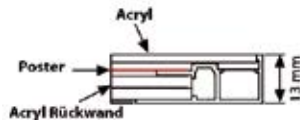

LED Magnetrahmen Economy, doppelseitig | LED Magnetic Frame Economy, double-sided

- Doppelseitiges Leuchtdisplay im TFT Look
- Extrem flache Bautiefe von nur 20 mm!
- Homogene und brillante Ausleuchtung durch LED-Flächenlicht
- Seilset kann für Anwendung im Hoch- oder Querformat genutzt werden
- *Double-sided LED magnetic frame in TFT look*
- *Depth only 20 mm!*
- *Absolutely homogeneous and brilliant illumination by LED LGP*
- *Cable outlet as standard on a short side together with ceiling suspension wire-set for use in portrait or landscape position*

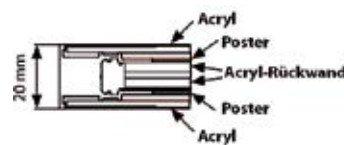

Art.-Nr.	Plakatmaß (mm)	Ausleuchtung (Lux)	Watt
ULDMENBA4X2000	210 x 297	3000	9,5
ULDMENBA3X2000	297 x 420	2600	14
ULDMENBA2X2000	420 x 594	2300	20
ULDMENBA1X2000	594 x 841	2000	28,5
ULDMENBA0X2000	841 x 1189	1400	40,5
ULDMENBB2X2000	500 x 700	2200	24
ULDMENBB1X2000	700 x 1000	1800	35



Kundenstopper HardLine | Pavement Sign HardLine

- Design-Kundenstopper für den Outdoor Einsatz*
 - Elegante, kantige Profilform
 - 33 mm HardLine-Klapprahmen in RAL 9005
 - 30/15 mm Rechteck-Gestell
 - Optional mit Top-Rahmen erhältlich
- *Design A-Board for outdoor use**
 - *Powder coated in RAL 9005, black*
 - *Elegant square profile shape*
 - *33 mm HardLine snap frame*
 - *30/15 rectangular legs*
 - *Optionally with top-frame*

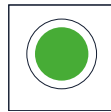
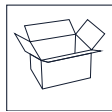
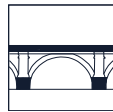

*Im Außeneinsatz empfehlen wir eine wasserfeste Folientasche einzusetzen.
*For outdoor use we recommend a waterproof PET poster-pocket.



Art.-Nr.	Plakatmaß (mm)
UAB3350BA1X5001	594 x 841

Kundenstopper HardLine PLUS | Pavement Sign HardLine PLUS

- Design-Kundenstopper für den Outdoor Einsatz*
 - Elegante, kantige Profilform
 - 33 mm HardLine-Klapprahmen in RAL 9005
 - 30/15 mm Rechteck-Gestell
 - Integriertes Top-Schild für permanentes Branding im Maß 620 x 150 mm
- *Design A-Board for outdoor use**
 - *Powder coated in RAL 9005, black*
 - *Elegant square profile shape*
 - *33 mm HardLine snapframe*
 - *30/15 rectangular legs*
 - *Integrated header for permanent branding, size 150 x 620 mm*

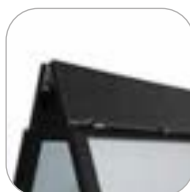
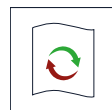
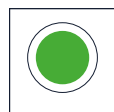
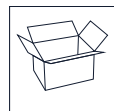
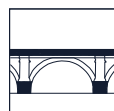

Art.-Nr.	Plakatmaß (mm)	Top-Schild (mm)
UAB3350BA1X5002	594 x 841	620 x 150

*Im Außeneinsatz empfehlen wir eine wasserfeste Folientasche einzusetzen.
*For outdoor use we recommend a waterproof PET poster-pocket.

Kundenstopper SQUARE | Pavement sign SQUARE



- Mobiler Plakatständer*
 - Geeignet für den Einsatz im windgeschützten Außen- und Innenbereich
 - Elegantes, kantiges Design
 - 33 mm HardLine-Klapprahmen in RAL 7026
 - Gestell und T-Füße aus Stahl-Rechteckprofil
 - Laufrollen mit Feststell-Bremse
 - Ausführung mit Top-Schild auf Anfrage
- *Mobile pavement sign**
 - *Suitable for use in wind-protected outdoor and indoor areas*
 - *Stylish angular design*
 - *33 mm HardLine snapframe, RAL 7026 powder-coated*
 - *Stand and feet made of steel rectangle profile*
 - *Castors with parking brake*
 - *Version for header-application on request*



Art.-Nr.	Abmessungen (mm)	Plakatformat (mm)
PRJ0101585	730 x 1195 x 400	594 x 841
6100105	Wasserfeste Folientasche DIN A1	594 x 841

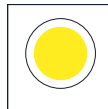
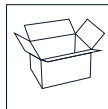

*Im Außeneinsatz empfehlen wir eine wasserfeste Folientasche einzusetzen.
*For outdoor use we recommend a waterproof PET poster-pocket.

Kundenstopper Wheel | Pavement sign Wheel



- Auffälliger Outdoor-Kundenstopper
 - Wasserfester 35 mm Klapprahmen
 - Sehr standfest
 - Metallrahmen mit Laufrollen für einfachen Transport
 - Logofläche oberhalb des Rahmens
 - Rohrrahmen wird einfach in Bodenrahmen eingeklickt
 - Farbe schwarz, andere RAL Farben auf Anfrage!
- *Flashy pavement sign*
 - *35 mm waterproof snapframe*
 - *Very stable*
 - *Metal wheel with castors for easy move*
 - *Header panel can be used for permanent branding*
 - *Tubular frame will be simply clicked in base*
 - *Colour black, other RAL colors on request!*

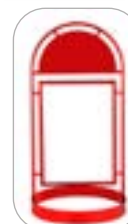

Art.-Nr.	Ausführung	Profil	Plakatmaß (mm)
PRJ0101554	wasserfest	35 mm	594 x 841
PRJ0101620	wasserfest	35 mm	500 x 700

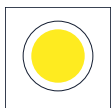

Inkl. Laufrollen / Incl. Wheels

WindPro® LED | WindPro® LED

- Innovativer, wasserdichter Kundenstopper in modernem Design
 - Umschaltbar mit Fernbedienung von „energiesparend - 650 bis 700 Lux“ in der Nacht, auf „sehr hell - 1000 - 1200 Lux“ am Tag
 - Betriebszeit (abhängig vom Modus) zwischen 12 und 24 Stunden
 - Leistungsstarke Lithium-Eisenphosphat Batterie unsichtbar im Kunststoff-Fuß verschlossen
 - Abschließbarer, schwarzer Passepartoutrahmen aus Polycarbonat
 - Das Plakat wird mit Klemmen fixiert
 - Transporthilfe ist im Lieferumfang enthalten
- *Innovative, waterproof pavement sign in modern design*
 - *The mode can be switched remote from "energy-saving - 650 - 700 Lux" in the night, to "bright - 1000 - 1200 Lux" during the day*
 - *The operation time is depending on mode 12-24 hours*
 - *The powerful LiFePO4 battery is hidden locked in the base – a digital display indicates the charge status of the battery*
 - *The decorative cover-frame with black passepartout is made of polycarbonate and is lockable*
 - *The poster is fixed with clamps*
 - *Carry tool is included in delivery*

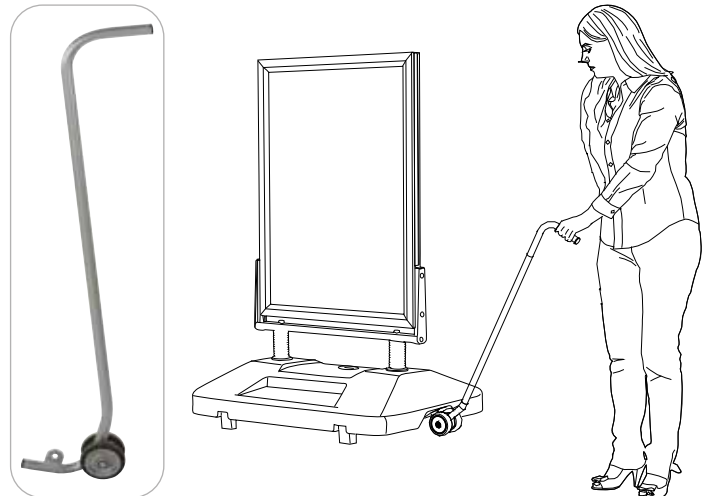
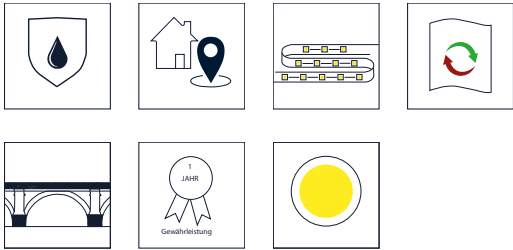

Art-Nr.	Plakatmaß (mm)	Ausführung
USWL000NA1X9999	594 x 841	Plakat
Zubehör		
UYPSWL0010X1000	Batterie	
UYPSWL0040X1000	Ladekabel/ Netzteil	

UYUP480945X1000
 Transporthilfe (Zugkraft max. 6-8 kg)
 Carry tool (Pulling force 6-8 kg max.)

WindPro® LED Economy | *WindPro® LED Economy*

- Wasserfester LED Kundenstopper für den Outdoor Einsatz
 - Helligkeit kann in 2 Stufen reguliert werden
 - Betriebszeit abhängig von der eingestellten Helligkeit zwischen 8 und 16 Stunden
 - Leistungsstarke Lithium-Eisenphosphat Batterie unsichtbar im Kunststoff-Fuß verschlossen
 - Einfacher Plakatwechsel durch bewährte Klapprahmen Technik
 - Wasserfest durch übergroße PET- Schutzfolie und integrierte Dichtung
- *Waterproof LED pavement sign for outdoor use*
 - *Brightness can be adjusted in 2 levels*
 - *Operating time depending on the set brightness between 8 and 16 hours*
 - *Powerful LiFePO4 battery invisibly locked in the plastic base*
 - *Easy change of poster by proven snapframe technology*
 - *Waterproof by oversized cover sheet and integral sealing*

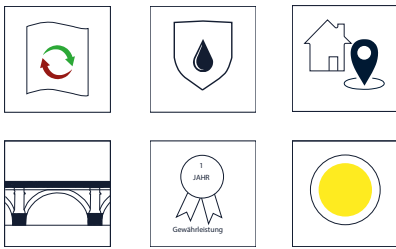

Art.-Nr.:	Farbe	Plakatmaß (mm)
USWLP00BA1X2000	schwarz	594 x 841
Art.-Nr.:	Bezeichnung	
UYUP480945X1000	Transporthilfe	
UYPSWL0010X1000	Ersatz Akku	



WindPro® LITE | *WindPro® LITE*

- Die Economy Version!
 - Patentierte Doppelfeder-Ausführung
 - Formschönes 33 mm Design-Klemmprofil
 - Safe Corner Ecken
 - Plakatabdeckung durch PET-Schutzfolien
 - Wasserablauföffnungen im Unterprofil
- *The economy version!*
 - *Patented double-spring version*
 - *Elegant 33 mm design-profile with safe corner solution*
 - *Poster cover by PET-sheet*
 - *Water drainage holes avoid moisture*

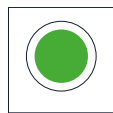
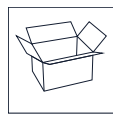
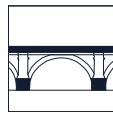

Art.-Nr.	Plakatmaß (mm)	Menge je Europalette	Farbe
1154037	594 x 841	14 Stück	schwarz
1154029	841 x 1189	6 Stück	schwarz
1154048	500 x 700	14 Stück	schwarz
1154030	700 x 1000	6 Stück	schwarz
1154038	594 x 841	14 Stück	silber
1154031	841 x 1189	6 Stück	silber
1154047	500 x 700	14 Stück	silber
1154032	700 x 1000	6 Stück	silber

Wir empfehlen im Außeneinsatz die Plakate auf Folie zu drucken.
For outdoor use we recommend to print the posters on foil.

WindPro® PLUS | WindPro® PLUS

- Die Premium Version!
 - Patentierte Doppelfeder-Ausführung
 - Robustes 44 mm Klemmprofil
 - Safe Corner Ecken
 - Wasserdicht durch übergroße Schutzfolie und im Unterprofil integrierte Dichtung
 - Einfacher Plakatwechsel dank Scharnierfunktion und Adhäsiv-Streifen
 - Design Kunststoff-Fuß
- *The premium version*
 - *Patented double-spring version*
 - *Sturdy 44 mm design-profile with safe corner solution*
 - *Waterproof by oversized anti-glare PET cover sheet and integrated sealing*
 - *Easy poster change thanks to hinge function and adhesive stripes to prefix poster*
 - *Design Waterbase*



Art.-Nr.	Plakatmaß (mm)	Menge je Europalette	Farbe
1154017	594 x 841	14 Stück	schwarz
1154046	841 x 1189	6 Stück	schwarz
1154044	700 x 1000	6 Stück	schwarz
1154018	594 x 841	14 Stück	silber
1154045	841 x 1189	6 Stück	silber
1154043	700 x 1000	6 Stück	silber

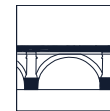

WindPro® & WindPro® Schwarz | WindPro® & WindPro® Black

- Der Bestseller!
 - Patentierte Doppelfeder-Ausführung
 - Bewährtes 40 mm Klemmprofil
 - Safe Corner Ecken
 - Wasserfest durch übergroße Schutzfolie und im Unterprofil eingeklebte Gummidichtung
 - Design Kunststoff-Fuß
- *The best seller!*
 - *Patented double-spring version*
 - *Proven 40 mm profile with safe corner solution*
 - *Waterproof by oversized anti-glare PET cover sheet and sealing*
 - *Design waterbase*

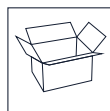
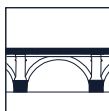

Art.-Nr.	Plakatmaß (mm)	Ausführung	Menge je Europalette	Farbe
1154033	594 x 841	Standard	14 Stück	schwarz
1154050	594 x 841	mit Topschild-Aufnahme	14 Stück	schwarz
1154034	841 x 1189	Standard	6 Stück	schwarz
1154007	500 x 700	Standard	14 Stück	schwarz
1154008	700 x 1000	Standard	6 Stück	schwarz
1154035	594 x 841	Standard	14 Stück	silber
1154051	594 x 841	mit Topschild-Aufnahme	14 Stück	silber
1154036	841 x 1189	Standard	6 Stück	silber
1154011	500 x 700	Standard	14 Stück	silber
1154012	700 x 1000	Standard	6 Stück	silber



Topschild-Aufnahme
Header-application



Mit permanentem Branding
With permanent branding



WindPro® WOOD | WindPro® WOOD



- Beidseitige Kreidetafel auf standfestem Kunststoff-Fuß mit Laufrollen
 - Massives, dunkel lasiertes Kiefernholz
 - Doppelfedern sorgen für einen sicheren Stand bei Wind und Wetter
 - Beschreibbar und feucht oder nass abwischbar und magnethaftend für Poster-Taschen
 - Mit Magnetfolien auch für Plakate nutzbar (nicht im Lieferumfang enthalten)
- *Double-sided chalkboard on sturdy plastic foot with castors*
 - *Solid, dark glazed firewood*
 - *Double springs ensure a secure position in wind and weather*
 - *Writable and moist or wet wipeable and ideal for magnetic poster pockets*
 - *With magnetic foil also usable as poster stand (not included in delivery)*

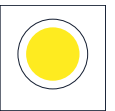
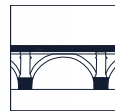

Art.-Nr.	Plakatformat (mm)	Ausführung	
1154057	460 x 680	Kreidetafel, magnethaftend	
1154052	590 x 780	Kreidetafel, magnethaftend	
1154060	590 x 780	Plakatständer inkl. 2 Magnetfolien	
Art.-Nr.	Beschreibung	Breite (mm)	Farbe
9000014	Kreidestifte 8er Set		bunt
UYUP397000X1000	Magnete, 10er Set	20	
Art.-Nr.	Beschreibung	Plakatmaß (mm)	Farbe
UPCMOB00A4X2000	Magnetfolie, DIN A4	210 x 297	schwarz
UYPSWPW010X1000	Magnetfolie, 460 x 680 mm	430 x 650	schwarz
UYPSWPW020X1000	Magnetfolie, 590 x 780 mm	560 x 750	schwarz

Kundenstopper WindSign FLEX | A-Board WindSign FLEX

- Moderner Kundenstopper in technischem Design
- Standfest durch federnde Lagerung
- Wasser befüllbarer Kunststoff-Fuß mit Laufrollen
- Gestell aus strapazierfähigem Kunststoff
- Einfacher Plakatwechsel durch flexiblen Kunststoff-Rahmen mit Antireflex-Folie
- Standardmodell komplett in schwarz, grau und Mix auf Anfrage!

- *Modern pavement sign in a technical design*
- *Stable thanks to resilient mounting*
- *Water-filled plastic foot with castors*
- *Completely made of durable plastic*
- *Easy poster change thanks to the flexible plastic frame with anti-reflective film*
- *Standard model completely in black, grey and mix on request!*

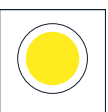
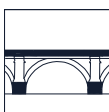
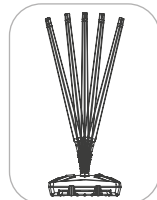

Art.-Nr.	Plakatmaß (mm)	Farbe
UPFS3300A1X2000	594 x 841	schwarz

Indoor Kundenstopper BLACK | Indoor A-Board BLACK

- Der Eyecatcher für den Innenbereich!
- Edles Design komplett in schwarz
- Aufmontierte 25 mm Klapprahmen mit schlagfester Polystyrol-Rückwand
- Stabiles Standgestell
- Auch Scharnier und Traverse schwarz pulverbeschichtet

- *The eyecatcher for indoor use!*
- *Noble Design completly in black color*
- *On mounted 25 mm snapframes with black polystyrene backing*
- *Stable legs*
- *Metall parts powder-coated in black color*

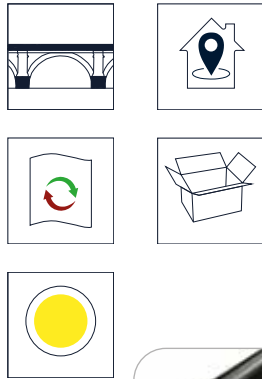

Art.-Nr.	Ausführung	Plakatformat (mm)
UAB255HCA1X5008	Gehrung	594 x 841

Kundenstopper Indoor | A-Board for Indoor

- Günstige Lösung für den Innenbereich
- Stabiles Standgestell
- 25 mm Klapprahmen mit PS-Rückwand

- *Inexpensive solution for indoor*
- *Stable legs*
- *25 mm snapframe with PS-backing*



Topschild optional

Art.-Nr.	Ausführung	Plakatmaß (mm)
UAB255HNA2X1000	Gehrung	420 x 594
UAB255HNA1X1000	Gehrung	594 x 841
UAB255HNB2X1000	Gehrung	500 x 700
UAB255HNB1X1000	Gehrung	700 x 1000
Art.-Nr.	Bezeichnung	Format
UYTT0000A1X1000	Aufsatzhalterung	DIN A1
UYTS3000A4X1000	Prospektkorb	DIN A4
UYFT0000A1X1000	Top-Schild	DIN A1



Aufsatzhalterung für Kundenstopper



DIN A4 Prospektkorb für Kundenstopper-Traverse



Topschild für Kundenstopper

Kundenstopper Outdoor Wasserfest | A-Board for Outdoor Waterproof

- Wasserfeste Lösung für den Außenbereich
- Stabiles Aluminium Standgestell
- 32 mm Klapprahmen mit Stahl-Rückwand
- Ecken auf Gehrung (Ausführung Rondo auf Anfrage!)
- Wasserdicht durch PET-Folientasche mit umlaufender Dichtung
- Wasserablauföffnungen im Unterprofil

- *Waterproof solution for outdoor*
- *Stable legs made of Aluminium*
- *32 mm snapframe with metall-backing*
- *Mitred corners (Rounded corners on request!)*
- *Waterproof thanks to PET poster-pocket with rubber sealing*
- *Water drainage holes*



Wasserfeste Version mit Rondo Ecken auf Anfrage!
Waterproof version with rounded corners on request!



Genial einfacher Plakatwechsel durch klappbare Postertasche
Easy poster change thanks poster pocket

Art.-Nr.	Beschreibung	Farbe
UAB325HNA2X5001	Kundenstopper Classic, Gehrung, Metallrückwand, Folientasche, A2	silber
UAB325HNA1X5000	Kundenstopper Classic, Gehrung, Metallrückwand, Folientasche, A1	silber
UAB325HBA1X5000	Kundenstopper, schwarz, Gehrung, Metallrückwand, Folientasche, A1	schwarz
UAB325HNAOX5000	Kundenstopper Classic, Gehrung, Metallrückwand, Folientasche, A0	silber
UAB325HNB2X5000	Kundenstopper Classic, Gehrung, Metallrückwand, Folientasche, B2	silber
UAB325HNB1X5001	Kundenstopper Classic, Gehrung, Metallrückwand, Folientasche, B1	silber

Kundenstopper Outdoor | A-Board Outdoor

- Einfache Lösung für den Außenbereich
- Stabiles Standgestell
- 32 mm Klapprahmen mit Stahl-Rückwand
- Hochwertige PET Schutzfolien
- Wasserablauföffnungen im Unterprofil
- Wetterfest

- *Basic solution for outdoor*
- *Stable legs*
- *32 mm snapframe with metall-backing*
- *PET cover sheets*
- *Water drainage holes*
- *Weatherproof*



Topschild für Kundenstopper



Prospektkorb für Kundenstopper-
Traverse



Aufsatzhalterung für Kundenstopper

Art.-Nr. Gehrung	Art.-Nr. Rondo	Plakatmaß (mm)	Farbe
UAB325HNA2X1000	UAB320HNA2X1000	420 x 594	silber
UAB325HNA1X1000		594 x 841	silber
	UAB320HNA1X1000	594 x 841	silber
UAB325HNAOX1000	UAB320HNAOX1000	841 x 1189	silber
UAB325HNB2X1000	UAB320HNB2X1000	500 x 700	silber
UAB325HNB1X1000	UAB320HNB1X1000	700 x 1000	silber
UAB325HBA2X2000		420 x 594	schwarz
UAB325HBA1X7700		594 x 841	schwarz
UAB325HBAOX2000		841 x 1189	schwarz
UAB325HBB2X2000		500 x 700	schwarz
UAB325HBB1X2000		700 x 1000	schwarz
Art.-Nr.	Bezeichnung	Format	Format
UYTT0000A1X1000	Aufsatzhalterung	DIN A1	DIN A1
UYTS3000A4X1000	Prospektkorb	DIN A4	DIN A4
UYFT0000A1X1000	Top-Schild	DIN A1	DIN A1



Ausführung Gehrung
Mitred Corners



Ausführung Rondo
Rounded Corners

Wir empfehlen im Außeneinsatz die Plakate auf Folie zu drucken.
For outdoor use we recommend to print the posters on foil.

Stahlrohr Kundenstopper, abgerundet | Iron A-Board

- Stabiler Kundenstopper aus 25 mm Stahlrohr
- Integriertes Top-Schild
- Optimaler Plakatschutz durch Magnetfolie (Magnetfolie schützt vor Spritzwasser)
- Erhältlich in silber, weiß oder schwarz pulverbeschichtet
- Auch für den Außeneinsatz geeignet, wetterfest

- Stable pavement sign made of 25 mm tubular steel
- Integrated top sign
- Poster protection by magnetic foil (Magnetic foil protects against splash water)
- Available in silver, white or black powder coated
- Also for outdoor use, weatherproof

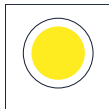
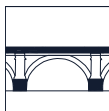

Art.-Nr.	Plakatmaß (mm)	Farbe
UABD255NA1X1000	594 x 841	weiß
UABD255BA1X1000	594 x 841	schwarz

Kundenstopper PremiumPlus | A-Board PremiumPlus

- Design Kundenstopper mit hochwertiger Aluminiumkonstruktion
- Gestell aus stabilem Rechteckprofil mit zwei aufmontierten 30 mm Klapprahmen
- PS-Rückwände
- PET-Schutzfolien
- Werkzeugloser Wechsel der Logoplatte durch Klemmleisten Technik
- Wasserfeste Version auf Anfrage*

- Design pavement sign with high-quality aluminium construction
- Stand made of sturdy rectangular profile with two mounted 30 mm snap frames
- Polystyrene backings
- PET cover-sheets
- Toolless change of header by snap-technology
- Waterproof version on request*

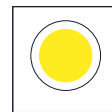
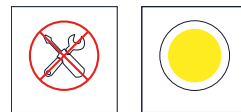
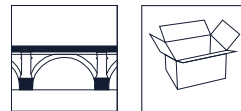

Art.-Nr.	Plakatmaß (DIN/mm)
UAPO305NA2X1000	A2
UAPO305NA1X1000	A1
UAPO305NA0X1000	A0
UAPO305NB2X1000	500 x 700
UAPO305NB1X1000	700 x 1000



* Wir empfehlen im Außeneinsatz die Plakate auf Folie zu drucken.
* For outdoor use we recommend to print the posters on foil.

Dreieck Plakatständer | Triangle Poster Stand

- Mobile Dreieck-Plakatständer für allseits sichtbare Werbung und Promotion
- Stabiles, faltbares Gestell aus Alu-Rechteckprofil
- Einfacher Plakatwechsel dank bewährter Klemmprofiltechnik
- Hochwertige PET-Schutzfolien
- Einzeln verpackt im Karton

- *Mobile poster stand for universally visible advertising*
- *Stand made off sturdy foldable aluminium rectangular profile*
- *Easy change of graphics thanks to proven clamping profile technology*
- *PET cover sheets*
- *Individually packed in carton*

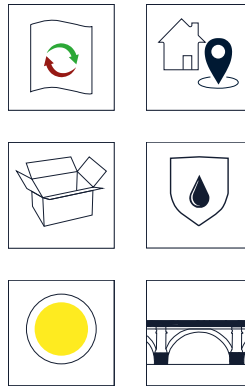

Art.-Nr.	Ausführung		Profil	Abmessung (mm)	Plakatformat
PRJ0101454	Economy, Indoor		25 mm	670 x 1050 x 670	3 x DIN A1
PRJ0100782	XXL, Outdoor	Wasserfest	35 mm	670 x 1900 x 670	3 x DIN A1

Hunde Tankstelle | Dog Station

- Stabiler Korpus aus Aluminium, silberfarbig oder schwarz
- 2 Näpfe aus Edelstahl mit 2,5 Liter Füllmenge
- Wasserfester DIN A1 Klapprahmen
- Abmessung: 640 x 1000 x 420 mm
- Ausführung SIGN mit Werbefläche

- *Stable aluminum base in silver or black*
- *2 stainless steel bowls, 2.5 liter capacity*
- *Waterproof DIN A1 snap frame*
- *Dimensions: 640 x 1000 x 420 mm*
- *Version SIGN with advertising space*

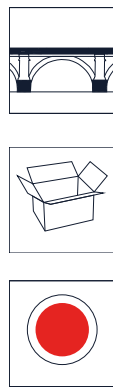

Art.-Nr.	Abmessung (mm)	Plakatformat (mm)	Farbe
UOPRN100A1X2000	640 x 1050 x 420	594 x 841	silber
UOPRB100A1X2000	640 x 1050 x 420	594 x 841	schwarz
UOPRN20010X2000	640 x 800 x 420	640 x 690	silber



Version "Sign"

Werbe-Fahrradständer Economy | *Advertising bicycle stand Economy*

- Vielseitig einsetzbares Outdoor Display
 - Plakatständer mit wasserfestem 25 mm Klapprahmen
 - Einstellplätze für 4 Fahrräder
 - Mobil durch integrierte Laufrollen
- *Versatile outdoor display for poster advertising*
 - *Poster stand with waterproof 25 mm snap frame*
 - *Parking spaces for 4 bikes*
 - *Mobile thanks to integrated castors*

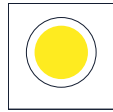
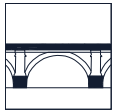

Art.-Nr.	Plakatmaß (mm)
UIB205CNA1X5003	594 x 841

Dekorativer Infoständer | Decorative Menuboard



- Infoständer mit dekorativer, schwerer Bodenplatte für festen Stand
- Klapprahmen kann im Hoch- und im Querformat genutzt werden
- Ovale Zentralprofil
- Ecken: Rondo oder Gehrung
- Farben: Schwarz und silber

- *Menuboard with decorative, heavy base plate for a firm stand*
- *Snapframe can be used portrait or landscape*
- *Elliptic central upright*
- *Rounded or Mitred Corners*
- *Black or silver Color*

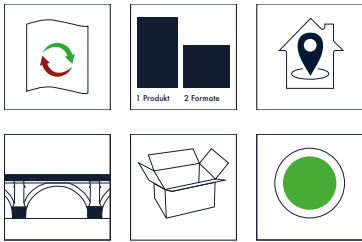

Art.-Nr. Gehrung	Art.-Nr. Rondo	Plakatmaß (mm)	Farbe
UDMB1N05A4X1000	UDMB1N00A4X2000	210 x 297	silber
UDMB1N05A3X1000	UDMB1N00A3X1000	297 x 420	silber
UDMB1N05A2X2000	UDMB1N00A2X2000	420 x 594	silber
UDMB1B05A4X2000	UDMB1B00A4X2000	210 x 297	schwarz
UDMB1B05A3X2000	UDMB1B00A3X2000	297 x 420	schwarz
UDMB1B05A2X2000	UDMB1B00A2X2000	420 x 594	schwarz



Infoständer SIGN | Menuboard SIGN



- Aufmerksamkeitsstarker Infoständer
- Stabile Stahl-Fußplatte
- Ovale Zentralprofil mit integrierter Systemnut
- Doppelseitiger Einschubrahmen im 25 mm Profil mit 6 mm Einschuböffnung
- DIN A2 nutzbar im Hoch- oder Querformat, DIN A1 im Hochformat
- PET-Schutzfolien mit Trennplatte
- Paketdienstfähige Einzelverpackung

- *Eye-catching information stand*
- *Stable steel base plate*
- *Oval central upright with integrated system groove*
- *Double-sided slide-in frame in 25 mm profile with 6 mm opening*
- *DIN A2 can be used in portrait or landscape format, DIN A1 in portrait format*
- *PET protective films with intermediate separating plate*
- *Individual packaging suitable for parcel service*



Art.-Nr.	Farbe	Plakatmaß (mm)
UIBSHN00A2X2000	silber	420 x 594
UIBSHN00A1X2000	silber	594 x 841
UIBSHB00A2X2000	schwarz	420 x 594
UIBSHB00A1X2000	schwarz	594 x 841

Gewölbter Infoständer | Curved Menuboard

- Eleganter Infoständer mit gewölbtem Zentralprofil
- Klapprahmen kann im Hoch- und im Querformat genutzt werden
- Stabile Bodenplatte
- Erhältliche Farben: Silber und Schwarz
- Auf Anfrage auch in Kupfer, Perlweiß, Pale Rose und Erdfarben erhältlich
- *Stylish Menuboard with curved leg*
- *Snapframe can be used portrait or landscape position*
- *Stable base plate*
- *Available colors: silver or black*
- *Special colours on request: Copper, pearl white, pale rose and earth colors*



Sonderfarben auf Anfrage
Special colours on request

Art.-Nr.	Ausführung	Farbe	Höhe max. (mm)	Höhe min. (mm)	Plakatmaß (mm)
UCUMBB05A4X1000	Gehrung	Schwarz/Black	1215	1180	210 x 297
UCUMBB05A3X1000	Gehrung	Schwarz/Black	1265	1212	297 x 420
UCUMBN05A4X1000	Gehrung	Silber/Silver	1215	1180	210 x 297
UCUMBN05A3X1000	Gehrung	Silber/Silver	1265	1212	297 x 420
UCUMBN00A4X1000	Rondo	Silber/Silver	1215	1180	210 x 297
UCUMBN00A3X1000	Rondo	Silber/Silver	1265	1212	297 x 420

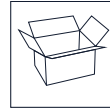
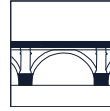

Infoständer Konkav | Arc Menuboard

- Stilvoller Infoständer im geschwungenen Design
- Elegante Präsentation von Speisekarten oder Informationen
- Standfestes Gestell aus pulverbeschichtetem Stahl
- Einfacher Wechsel der Einleger durch Magnetfolie
- *Stylish menuboard with curved design*
- *Elegant presentation of information*
- *Stable base and upright made of powder-coated steel*
- *Easy change of graphic by magnetic poster cover*

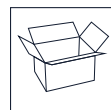
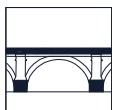

Art.-Nr.	Plakatmaß (mm)	Ausführung
UAMBOP0GA4X2000	210 x 297	silber
UAMBOP0GA3X2000	297 x 420	silber
UAMBOP0BA4X2000	210 x 297	schwarz
UAMBOP0BA3X2000	297 x 420	schwarz

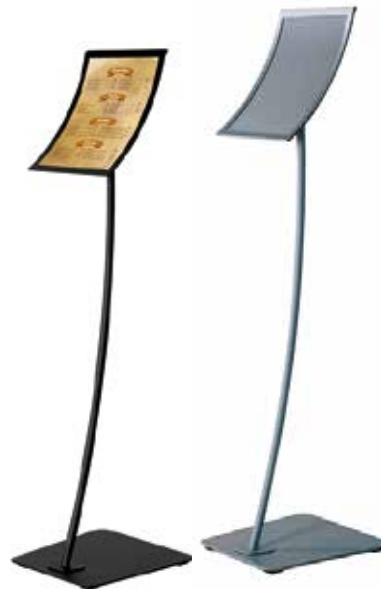
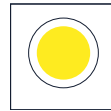

Infoständer Economy, einseitig | Economy Menuboard, single sided

- **Der preisgünstige Alleskönner!**
- In der Höhe und im Format einstellbar
- Stabile, runde Bodenplatte aus Stahl
- Teleskopierbares Zentralprofil mit 25 mm Alu-Klapprahmen
- Erhältlich in silber oder schwarz pulverbeschichtet
- **The inexpensive all-rounder!**
- Telescopic Menuboard with snapframe
- Provides portrait and landscape adjustment easily
- Metal base plate with central upright pole
- Available in silver or black powder coated

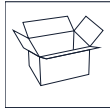
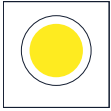
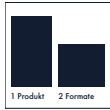

Art.-Nr.	Farbe	Plakatmaß (mm)	Max. Höhe (mm)
UMBT510NA4X2000	silber	210 x 297	1305
UMBT510NA3X2000	silber	297 x 420	1385
UMBT510BA4X2000	schwarz	210 x 297	1305
UMBT510BA3X2000	schwarz	297 x 420	1385



Infoständer Economy, doppelseitig | Economy Menuboard, double sided

- **Der preisgünstige Alleskönner!**
- In der Höhe und im Format einstellbar
- Stabile, runde Bodenplatte aus Stahl
- Teleskopierbares Zentralprofil mit doppelseitig nutzbarem Alu-Einschubrahmen
- Erhältlich in silber oder schwarz pulverbeschichtet
- **The inexpensive all-rounder!**
- Telescopic Menuboard with slide-in frame
- Provides portrait and landscape adjustment easily
- Metal base plate with central upright pole
- Available in silver or black powder coated

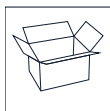
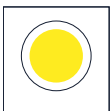
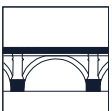

Art.-Nr.	Farbe	Plakatmaß (mm)	Max. Höhe (mm)
UMBD20NA4X2000	silber	210 x 297	1405
UMBD20NA3X2000	silber	297 x 420	1528
UMBD20BA4X2000	schwarz	210 x 297	1405
UMBD20BA3X2000	schwarz	297 x 420	1528



Klassischer Infoständer | Classical Menuboard

- Der Klassiker unter den Infoständern
- 25 mm Klapprahmen im Hoch- oder Querformat nutzbar
- Gesamthöhe 1000 mm

- *The classic menuboard*
- *Snapframe can be used portrait or landscape position*
- *Total height 1000 mm*

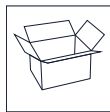
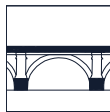

Art.-Nr. Gehrung	Art.-Nr. Rondo	Plakatmaß (mm)
UCMB1N05A4X1000	UCMB1N00A4X1000	210 x 297
UCMB1N05A3X1000	UCMB1N00A3X1000	297 x 420



Flexibler Infoständer | Flexible Menuboard

- Infoständer mit 25 mm Profil-Klapprahmen
- Im Hoch- oder Querformat nutzbar
- Höhenverstellbares Gestell (Höhe max. 1205 mm, Höhe min. 865 mm)
- Klapprahmen in der Neigung einstellbar

- *Menuboard with 25 mm snapframe*
- *Snapframe can be used portrait or landscape position*
- *Height adjustable stand (High max. 1205 mm, High min. 865 mm)*
- *Snapframe can be adjusted in inclination*

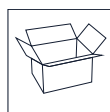
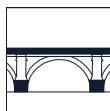

Art.-Nr.	Plakatmaß (mm)	Höhe max. (mm)	Höhe min. (mm)
UDMB6005A4X1000	210 x 297	1205	865
UDMB6005A3X1000	297 x 420	1250	910



Folder Infoständer | Folder Menuboard

- Infoständer mit Acrylablage und Ordner-Mechanik
- Ideal zum Blättern von Speisekarten und Preislisten
- DIN A4 Prospektbox optional
- *Menuboard with clear acrylic shelf and ring binder panel*
- *Ideal for menu pages or pricelists*
- *DIN A4 brochure holder optional*

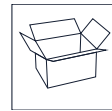
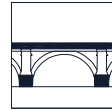
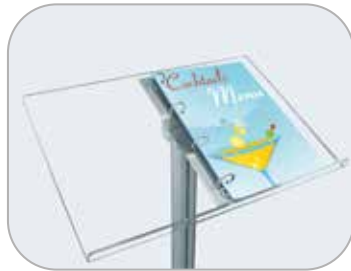

Art.-Nr.	Format (DIN)
UDMB2002A4X1000	2 x A4

NEU! Infoständer WOOD | NEW! WOOD Menuboard

- Nachhaltiger und moderner Infoständer aus zertifiziertem Buchenholz, dunkel lasiert
- 20 mm starker Holz-Sockel mit Bodengleitern
- Zentrales Holz-Rechteckprofil
- Holz-Einschubrahmen für einfachen Motivwechsel
- Wahlweise mit Plakat-Einschubrahmen oder als Kreidetafel-Rahmen
- Einzeln verpackt im Karton
- *Sustainable and modern menuboard made of certified beech wood, dark glazed*
- *20 mm base with floor-gliders*
- *Central upright in square shape*
- *Wooden slide-in frame for easy change of inlays*
- *Optionally with poster slide-in frame or as a chalkboard frame*
- *Comes in individual packing*



Art.-Nr.	Ausführung	Sichtmaß (mm)	Plakatmaß (mm)	Sichtmaß (mm)
PRJ0101621	Plakat	297 x 1000 x 350	210 x 297	203 x 290
PRJ0101622	Plakat	297 x 1200 x 350	297 x 420	290 x 413
PRJ0101767	Kreidetafel	297 x 1000 x 350		203 x 290
PRJ0101766	Kreidetafel	297 x 1200 x 350		290 x 413

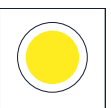
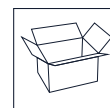

Plakatständer Economy | Poster Stand Economy

- Kostengünstiger einseitiger Plakatständer
- Stabile Stahl-Fußplatte in RAL 9006
- Teilbares, ovales Zentralprofil mit integrierter Systemnut
- Klapprahmen im 25 mm Profil auf Gehrung
- Mit Zusatzrahmen auch doppelseitig nutzbar
- Paketdienstfähige Verpackung

- *Inexpensive single-sided poster stand*
- *Stable steel base plate in RAL 9006*
- *Dividable elliptic central upright with inbuilt system groove*
- *Mitred snap frame in 25 mm profile*
- *Additional frame for double sided use as option*
- *Packaging suitable for parcel service*

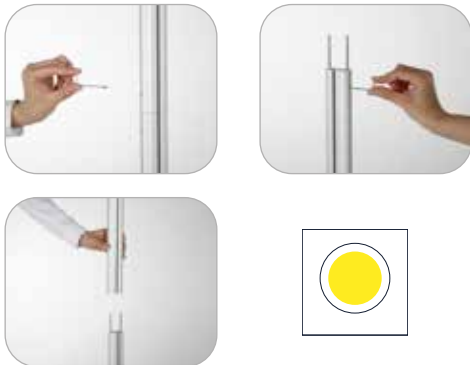

Art.-Nr.	Ausführung	Plakatmaß (mm)
PRJ0101428	einseitig	594 x 841
UFSL0000A1X2000	Zusatzrahmen	594 x 841

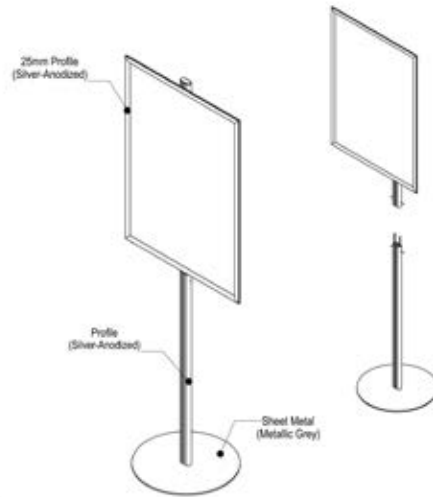
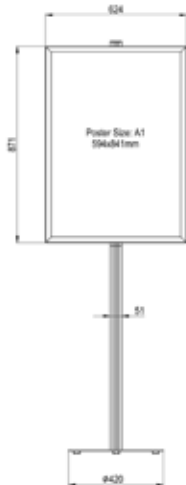
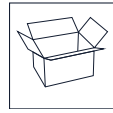
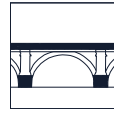

Plakatständer PURE | Info Board PURE

- Doppelseitiger Poster-Ständer
- Silberfarbiges Gestell in Kombination mit zwei Klapprahmen im 25mm Profil
- Einfacher und schneller Motivwechsel durch bewährte Klapprahmenteknik
- Stabiler Stand durch Stahl-Fußplatte und Stahl-Gestell

- *Double-sided poster stand*
- *Silver colored frame in combination with two snap-frames in 25mm profile*
- *Easy and fast poster change through proven snap-frame technology*
- *Stable stand thanks to steel base plate and sturdy steel frame*

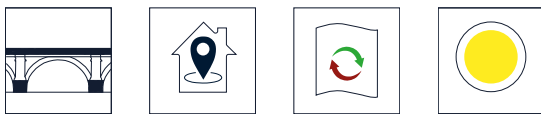

Art.-Nr.	Anwendung	Farbe	Format	Abmessung (mm)
PRJ0101232	Doppelseitig	silber	2 x DIN A1	630 x 1305 x 330
PRJ0101233	Doppelseitig	schwarz	2 x DIN A1	630 x 1305 x 330

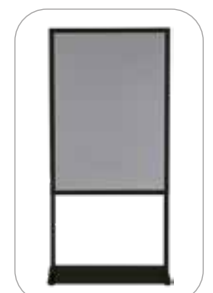

Version schwarz
Black version

Eco Plakatständer, doppelseitig | Eco Infoboard, double-sided

- Einreihiger oder zweireihiger Plakatständer, doppelseitig
- Preisgünstig
- Versetzte Einschubrahmen
- Silberfarbig oder schwarz
- Single-row or double-row poster stand, double-sided
- Inexpensive
- Slide in poster frame
- Silver or black



einreihig



zweireihig



500 x 1700 mm

Art-Nr. Silber	Art.-Nr. Schwarz	Plakatmaß	Beschreibung
UIBS00N1A1X1000	UIBS00C1A1X1000	594 x 841	einreihig
UIBS00N2A1X1000	UIBS00C2A1X1000	594 x 841	zweireihig
	UIBS00C151X1000	500 x 1700	einreihig

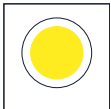
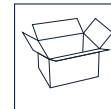

Ovalfuß-Plakatständer, doppelseitig | Oval Info Board, double-sided

- Preisgünstiger, doppelseitiger Plakatständer
- Einschubrahmen im Hochformat
- Ovale Fußplatte
- Komplettsilberfarbig
- Economic, double-sided poster stand
- Slide-in frame in portrait
- Oval base
- Silver colored

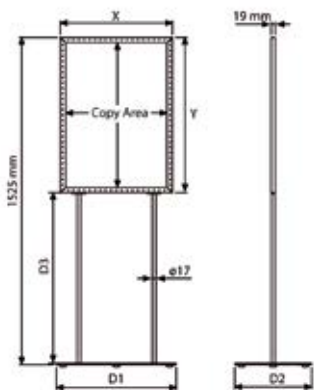
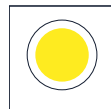
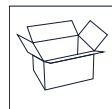

H-Fuß Plakatständer optional
H-Foot Info Board optional



Art.-Nr.	Plakatmaß (mm)
UIBS10N0A2X1000	420 x 594
UIBS10N0A1X1000	594 x 841
UIBS10N0B2X1000	500 x 700

Universeller Schaukasten | Universal Officeboard

- Info-Schaukasten mit magnethaftender Stahl-Rückwand, seitliches Schloss
- Poster-Schaukasten mit Kunststoff-Rückwand, Plakatclipsen und seitlichem Schloss
- Für den Inneneinsatz
- Nutzbare Bautiefe 27 mm
- Frontscheibe aus schlagfestem PETG



Art.-Nr.	Format	Ausführung
USBNU000A2X1000	DIN A2	Poster Schaukasten
USBNU000A1X1000	DIN A1	Poster Schaukasten
USBNU000A0X1000	DIN A0	Poster Schaukasten
USBNU204A4X1000	4 x DIN A4 hoch	Info Schaukasten
USBNU206A4X2000	6 x DIN A4 hoch	Info Schaukasten
USBNU209A4X1000	9 x DIN A4 hoch	Info Schaukasten
Art.-Nr.	Beschreibung	
UYUP397000X1000	Magnete	DM = 20 mm, 10er Set
UYUP427510X1000	Ersatzschlüssel	

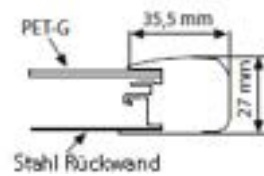

Info Schaukasten

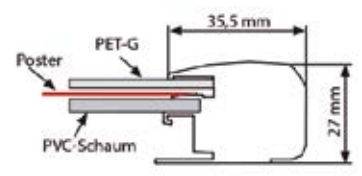

Poster Schaukasten

Outdoor Schaukasten | Outdoor Showboard

- Abschließbarer Schaukasten für den Außeneinsatz
- Nutzbare Bautiefe 36 mm
- Weiße, magnethaftende Rückwand und seitliches Schloss
- Frontscheibe aus schlagfestem PETG

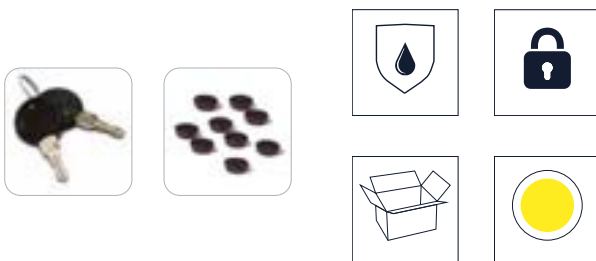

Art.-Nr.	Format
USBN2004A4X1000	4 x A4
USBN2006A4X1000	6 x A4
USBN2009A4X1000	9 x A4
USBN2012A4X1000	12 x A4
Art.-Nr.	Beschreibung
UYUP397000X1000	Magnete, DM = 20 mm, 10er Set
UYUP427510X1000	Ersatzschlüssel

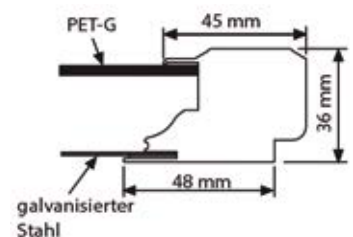

Indoor Schaukasten | Indoor Officeboard

- Abschließbarer Schaukasten für den Inneneinsatz
- Nutzbare Bautiefe 35 mm
- Weiße, magnethaftende Rückwand und Frontscheibe mit Schloss
- Frontscheibe aus schlagfestem PETG

- Lockable showcase for indoor use
- Usable depth 35 mm
- White, magnetic rear panel and lock in door
- Front sheet made of impact resistant PETG



Art.-Nr. Magnethaftend	Format	Sichtmaß (mm)
USBN5004A4X1000	4 x A4	474 x 657
USBN5006A4X1000	6 x A4	474 x 977
USBN5009A4X1000	9 x A4	704 x 977
Art.-Nr.	Beschreibung	
UYUP397000X1000	Magnete	DM = 20 mm, 10er Set
UYUP427510X1000	Ersatzschlüssel	

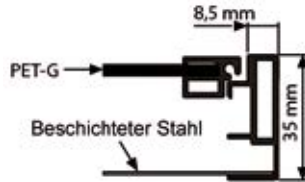

Holz-Staffelei Economy | Wooden Easel Economy

- Aus hochwertigem Kiefern-Holz, lasiert
- Ideal geeignet für Angebots- oder Werbetafeln aller Art
- Die Halterung für Tafeln ist in 3 Stufen höhenverstellbar
- Erhältlich in Natur oder dunkler Holz-Optik

- Made of high quality pine wood, glazed
- Ideal for all kinds of billboards
- The holder for panels is height adjustable in 3 steps
- Available in natural or dark wood look



Art.-Nr.	Ausführung	Höhe (mm)
USLBD00016X2000	Holz, dunkel	1595
USLBN00016X2000	Holz, Natur	1595



Holz-Staffelei | Wooden easel

- Solide Feldstaffelei produziert aus zertifiziertem Buchenholz
- Höhenverstellbar und im Neigungswinkel einstellbar
- Ideal geeignet für Kreide- oder Magnettafeln, Leinwände oder Posterrahmen

- Solid Easel made of certified beech wood
- Height adjustable
- Ideally suited for chalkboards or poster frames

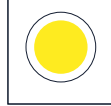
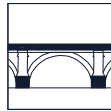

Art.-Nr.	Höhe max min (mm)
USLA000012X1000	1530 2050

Mobile Staffelei HOLZ | Mobile Easel WOOD

- Mobile Staffelei aus Holz
- Buche natur
- Ausstellfüße zusammenklappbar
- Ideal für Restaurants, Boutiquen, Kunstgalerien und Schulen

- Mobile easel made of beech wood
- Beech wood natural
- Folding feet collapsible
- Suitable for restaurants, art galleries or classrooms

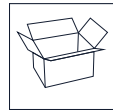

Nylon-Trageköcher
Nylon carrying case

Art.-Nr.	Höhe (mm)
UWPESLN010X2000	1500
Art.-Nr.	Beschreibung
UYUP067400X5001	Nylon-Trageköcher für Mobile Staffelei



Mobile Staffelei | Mobile Easel



- Mobile Staffelei aus Metall
- Erhältlich in grau, schwarz oder weiß
- Ausstellfüße zusammenklappbar
- Ideal für Restaurants, Boutiquen, Kunstgalerien und Schulen

- Mobile easel made of steel
- Available in gray, black or white
- Folding feet collapsible
- Suitable for restaurants, art galleries or classrooms



Nylon-Trageköcher
Nylon carrying case



Ausführung in weiß
Version in white



Ausführung in schwarz
Version in black



Ausführung in grau
Version in grey

Art.-Nr.	Höhe (mm)	Farbe
UPESLOG015X1000	1500	Grau
UPESLOB015X1000	1500	Schwarz
UPESLOW015X5000	1500	Weiß
Art.-Nr.	Beschreibung	
UYUP067400X5001	Nylon-Trageköcher für Mobile Staffelei	

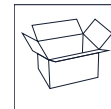

Holz-Kundenstopper Easel | Wooden pavement sign Easel

- Gehwegaufsteller aus zertifiziertem, massivem Buchenholz, dunkel lasiert
- Magnetische Kreidetafel, beschreibbar und feucht oder nass abwischbar

- Pavement sign made of certified, solid beech wood, dark glazed
- Magnetic chalkboard for the use of PET pockets, writable and moist or wet wipeable



Art.-Nr.	Beschreibung	Abmessung (mm)
UWBAD10000X2000	Staffelei	520 x 1030
UYPBAD1020X1000	Kreidetafel (magnetisch)	600 x 800
Art.-Nr.	Beschreibung	Farbe
9000014	Kreidestifte 8er Set	bunt
UYUP397000X1000	Magnete DM = 20 mm, 10er Set	
UPCM0B00A4X2000	PET Pocket	schwarz

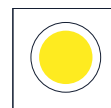
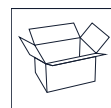

Boden-Prospektständer Rapid | *Floor brochure stand Rapid*

- Mobiler Prospektständer
- Alu-Rahmengestell
- 3 DIN A4 Ablagen aus satiniertem Acrylglas
- Neutrales Top-Schild für ein permanentes Branding
- *Mobile brochure stand*
- *Aluminium frame stand*
- *3 DIN A4 shelves made of frosted acrylic glass*
- *Neutral top-sign for a permanent branding*

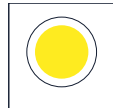
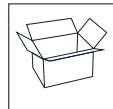

Art.-Nr.	Format (DIN)	Abmessungen (BxHxT / mm)	Preis (€)
URDB0002A4X1000	2 x A4	265 x 1000 x 350	70,08
URDB0003A4X1000	3 x A4	265 x 1290 x 350	84,94

Boden-Prospektständer Cocktail, breit/schmal | *Floor brochure stand Cocktail wide/narrow*

- Modularer Prospektständer
- Wenig Platzbedarf aber viel Raum für Prospekte
- Gestell aus silberfarbigem Stahl – erhältlich in 2 Breiten
- Prospektboxen können variabel an den Traversen befestigt werden
- Gesamthöhe 1620 mm
- *Modular brochure stand*
- *Little footprint but plenty of space for brochures*
- *Silver steel stand - available in 2 widths*
- *Brochure boxes can be variably attached to the cross-bars*
- *Total height 1620 mm*

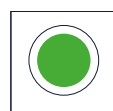
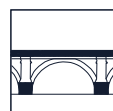

Art.-Nr.	Ausführung	Gestell	Format
1310010	doppelseitig	schmal	16 x DIN A4
1310011	doppelseitig	breit	24 x DIN A4

Falt-Prospektständer Neu | Foldable brochure stand New

- Faltbarer Prospektständer in moderner Optik
 - 5 glasklare Ablagen für DIN A4 Prospekte
 - Einfach zusammenklappbar
 - Nylon-Transporttasche mit Innenverstärkung
 - Kann mit Prospekten transportiert werden
- *Foldable brochure stand in modern design*
 - *5 shelves for DIN A4 leaflets Shelves*
 - *Easy to fold*
 - *Nylon transport bag with interior reinforcement*
 - *Can be carried with leaflets*



Art.-Nr.	Format (DIN)
UZZEPS0100X1000	5 x DIN A4

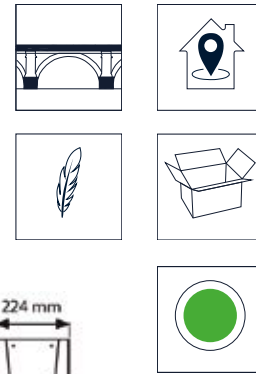
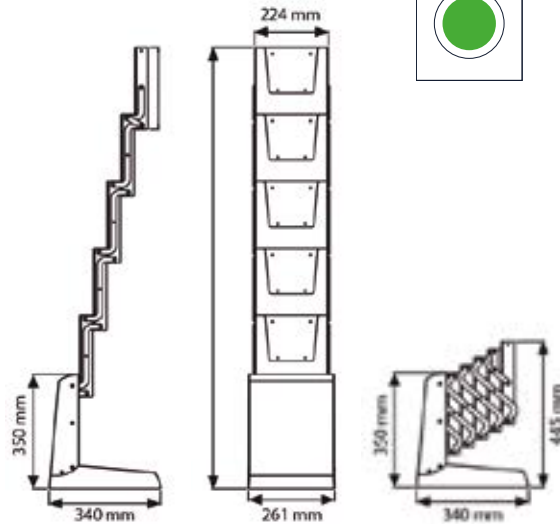

Boden-Prospektständer Pillar | Floor brochure stand Pillar

- Prospektständer mit zentralem Aluminium-Profil und Mehrfach-Prospektboxen
 - Erhältlich für 3 x DIN A4 Prospekte oder 6 x DIN Lang Prospekte
- *Brochure stand with central upright profile and multiple brochure boxes*
 - *Available for 3 x DIN A4 brochures or 6 x 1/3 DIN A4 brochures*

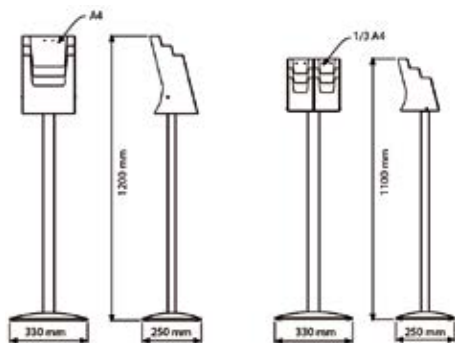

Art.-Nr.	Format (DIN)
UPBS3000A4X1000	3 x DIN A4
UPBS3000A43X1000	6 x DIN Lang

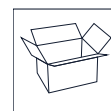

Boden-Prospektständer TWIST | *Brochure stand TWIST*

- Elegante Optik!
 - Stabiles Leitergestell in RAL 9006
 - Flexibel doppelseitig nutzbar dank Fußplatte mit Drehfunktion
 - Prospektboxen aus glasklarem Acryl, diese werden durch Metallhalterungen in Schrägposition gehalten (Prospektboxen sind nicht im Lieferumfang enthalten, diese müssen separat bestellt werden!)
 - Gesamthöhe 1711 mm
 - Permanentes Branding optional
- *Elegant look!*
 - *Sturdy ladder frame in RAL 9006*
 - *Flexible double-sided use thanks to rotatable base plate*
 - *Clear acrylic brochure boxes, this are held in an inclination position by strong metal supports (Clear acrylic brochure boxes are not included, these must be ordered separately!)*
 - *Total height 1711 mm*
 - *Permanent branding optional*



Art.-Nr.	Ausführung	Format (mm)
UHDL12G030X2000	Gestell	305 x 1800
UHDLOS6TA4X5000	Prospektablage 4 er Set	4 x 210 x 297

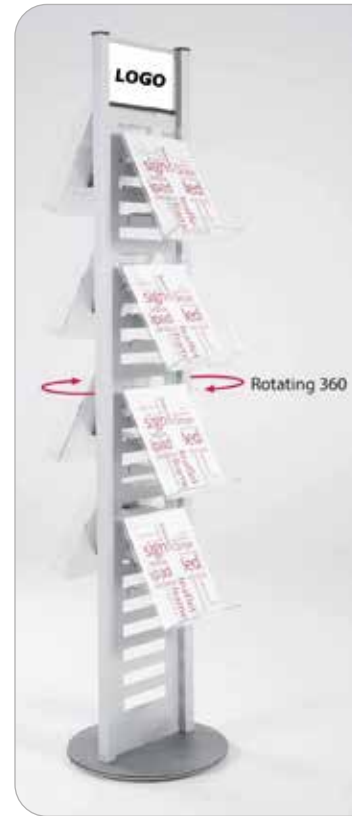
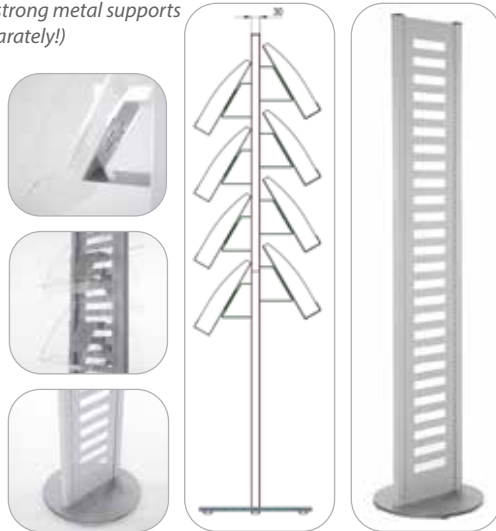

Dekorativer Boden-Prospektständer / Dekorativer Boden-Prospektständer Plus

Decorative floor brochure stand / Decorative floor brochure stand Plus

- Prospektständer mit silberfarbiger Bodenplatte und zentralem Ovalprofil
 - Glasklare DIN A4 Prospektablage für Hoch- oder Querformat aus schlagfestem Polycarbonat
 - Version "Plus" mit Acryl-Postertasche
- *Brochure stand with silver coloured base and central oval upright*
 - *Clear acrylic brochure holder for DIN A4 portrait or landscape made of high impact polycarbonate*
 - *Plus Version comes a long with easy to change header on top*

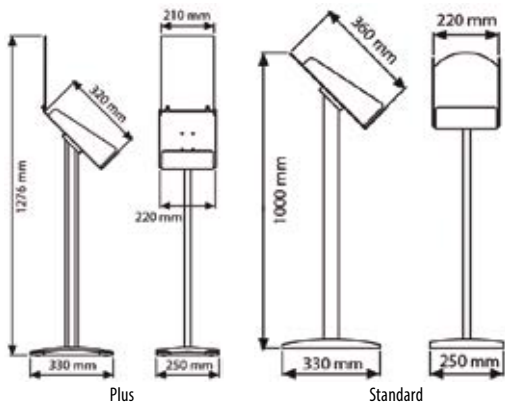
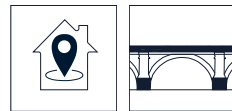

Art.-Nr.	Variante	Format (DIN)
UDBS10Y0A4X1000	Standard	A4 Querformat
UDBS10D0A4X1000	Standard	A4 Hochformat
UDBS20Y0A4X1000	Plus	A4 Querformat
UDBS20D0A4X1000	Plus	A4 Hochformat



Boden-Prospektständer Outdoor PLUS | Floor brochure stand Outdoor PLUS

- Praktischer Prospektständer für Innen- und Außen!
- Gestell und Prospektbox aus silberfarbigem Metall im Lochblech-Design
- Glasklare Info- oder Poster-Tasche für DIN A4 Hochformat mit seitlichem Einschub
- Mobil durch integrierte Laufrollen

- *Practical brochure stand for indoor and outdoor application!*
- *Stand and brochure box made of silver-colored metal in perforated design*
- *Crystal-clear info or poster pocket for A4 portrait format for lateral insertion*
- *Mobile thanks to integrated wheels*

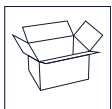

Art.-Nr.	Ausführung	Format
PRJ0101169	silber	DIN A4

Boden-Prospektständer Outdoor BLACK | Floor brochure stand Outdoor BLACK

- Praktischer Prospektständer für Innen- und Außeneinsatz
- Komplett in moderner schwarzer Optik
- 2 große Prospektboxen mit viel Platz für DIN A4 Prospekte oder Zeitschriften
- Schutz vor Feuchtigkeit durch glasklare, schlagfeste Polycarbonat-Abdeckungen
- Logofläche für permanentes Branding: 300 x 170 mm (B x H)
- Einfach zu bewegen durch integrierte Laufrollen und Traggriff

- *Practical brochure stand for in- and outdoor use*
- *Completely powder-coated in stylish black color*
- *2 boxes with large space for DIN A4 brochures or magazines*
- *Protection against moisture by clear, impact resistant polycarbonate cover-sheets*
- *Header: 300 x 170 mm (b x h) for permanent branding*
- *Easy to move by integrated wheels and handle*

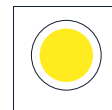
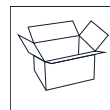
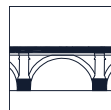

Art.-Nr.	Abmessung (mm)	Einlegeformat maximal (mm)
PRJ0101652	300 x 1256 x 394	2 Fächer je 254 x 350 x 170 mm

Falt-Prospektständer BLACK | *Foldable brochure stand BLACK*

- Faltbarer Prospektständer in komplett schwarzer Optik
- 5 Ablagen für DIN A4 Prospekte
- Einfach zusammenklappbar
- Nylon-Transporttasche
- Kann mit Prospekten transportiert werden

- *Foldable brochure stand in black design*
- *5 shelves for DIN A4 leaflets*
- *Easy to fold*
- *Nylon transport bag*
- *Can be carried with leaflets*



Art.-Nr.	Format
UZZE01B1A4X2000	5 x DIN A4



Falt-Prospektständer Acryl/Metall | *Foldable brochure stand Acrylic/Metal*

- Falt-Prospektständer Zick-Zack mit 6 Ablagen
- Zugang zu Prospekten von 2 Seiten
- Interessante Optik und sekundenschneller Aufbau
- Ablagen erhältlich in glasklarem Acryl oder schwarz gelochtem Blech
- Acryl-Version mit Transportkoffer aus Aluminium mit Styropor Innenverkleidung
- Metall-Version mit Transporttasche aus Nylon

- *Foldable Zick-Zack brochure stand with 6 shelves*
- *Access to brochures from 2 sides*
- *Nice design and easy set-up*
- *Shelves available in crystal clear acrylic or black perforated sheet metal*
- *Acrylic version with transport case made of aluminum with interior reinforcement*
- *Metal version with nylon transport bag*



Art.-Nr.	Format (mm)	Farbe	Ablage
1362003	6 x DIN A4	silber eloxiert	Acryl, glasklar
UFZHD10614X5001	6 x DIN A4	RAL 9005 schwarz	Metall gelocht



Boden-Prospektständer Zick-Zack | Floor brochure stand Zick-Zack

- Eleganter Prospektständer mit sechs Ablagen aus glasklarem Acryl und zentralem Ovalprofil, silber eloxiert
 - Von allen Seiten zugänglich
 - Einbeinig optional mit Top-Schild
 - Zweibeinig inklusive Top-Rahmen für individuelle Headline
 - Jetzt auch aus dunkel lasiertem Buchenholz erhältlich!
- *Elegant brochure stand with 6 clear shelves made of acrylic and central oval pole, silver anodised*
 - *Allows access from all sides*
 - *Standard one-leg version optional with header*
 - *Double leg version inclusive header frame for individual headline*
 - *Now also available in beech wood, dark glazed!*

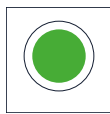
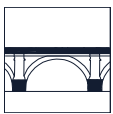

Art.-Nr.	Format (DIN)	Modell
UZZTLT0001X1000	6 x A4	1-Beinig Standard
UZZTLT0002X1000	6 x A4	1-Beinig Standard mit Top-Schild
UZZWD0005A4X2000	6 x A4	Holz, dunkel

Konvex-Plakatständer auf Zentralprofilgestell | Free standing convex box

- Auffälliger Plakatständer mit doppelseitigem Konvex-Rahmen
 - Stabile Bodenplatte mit Bodengleitern
 - Rundes Zentralrohr mit Systemnuten
 - Optional beleuchtet oder mit Prospektablage aus Acryl oder Metall
- *Poster stand with double sided curved frame*
 - *Stable base plate with floor gliders*
 - *Round central upright with inbuilt grooves*
 - *Optional brochure shelf made of acrylic glass or metal*

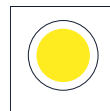
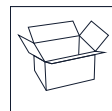
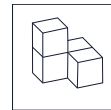

Art.-Nr.	Plakatmaß (mm)
UTTM014100X1000	420 x 594
UTTM014000X1000	594 x 841
UTTM014200X1000	500 x 700

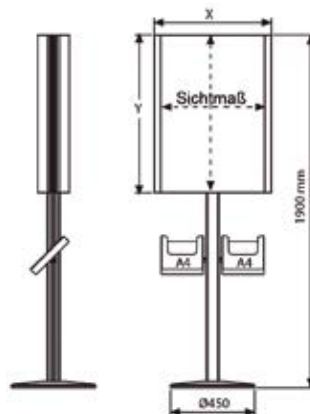
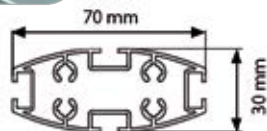

Boden-Prospektständer Brand | *Floor brochure stand Brand*

- Formschöner Boden-Prospektaufsteller aus hochwertigem Buchenholz, dunkel lasiert
 - Die leicht nach hinten geneigte Prospektpräsentation zieht alle Blicke auf sich
 - Die 3 DIN A4 Prospektablagen haben eine Fülltiefe von 120 mm
 - Optional mit permanentem Branding
 - Auch erhältlich in gerader Version als Merchandiser
- *Elegant floor brochure stand made of high-quality, beech wood, dark glazed*
 - *The slightly sloping brochure presentation draws everyone's attention*
 - *3 DIN A4 brochure trays have a filling depth of 120 mm*
 - *Optionally with permanent branding*
 - *Available also in straight upright version as merchandiser*

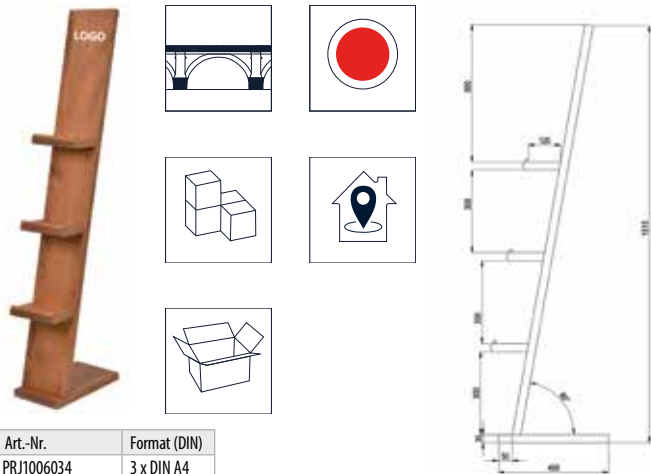

Art.-Nr.	Format (DIN)
PRJ1006034	3 x DIN A4



Boden-Prospektständer Wood Magazine | *Floor brochure stand Wood Magazine*

- Freistehender, doppelseitiger Prospektständer aus Holz kombiniert mit Acrylglas
 - Hochwertiges Buchenholz, dunkel lasiert
 - Glasklare Prospektboxen
 - Auch einseitig als Wandversion erhältlich
- *Freestanding, double sided wooden brochure stand combined with acrylic glass*
 - *High quality beech wood, dark glazed*
 - *Clear brochure boxes*
 - *Also available as a single sided wall version*



Wandversion 15 x DIN A4
Wall Version 15 x DIN A4



Freistehend 20 x DIN A4
Freestanding 20 x DIN A4



Freistehend 40 x DIN A4
Freestanding 40 x DIN A4



Art.-Nr.	Ausführung	Format (DIN)
UWMRFD15A4X2000	Freistehend	10 x A4
UWMRFD25A4X2000	Freistehend	20 x A4
UWMRFD35A4X2000	Freistehend	30 x A4
UWMRFD45A4X2000	Freistehend	40 x A4
UWMRWD15A4X2000	Wand	5 x A4
UWMRWD25A4X2000	Wand	10 x A4
UWMRWD35A4X2000	Wand	15 x A4
UWMRWD45A4X2000	Wand	20 x A4

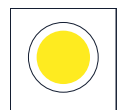
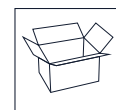
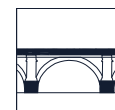

Variation 70 Prospektbox-Ständer | Variation 70 brochure stand

- Einseitiger oder doppelseitiger Prospektständer für 8 x DIN A4 Prospekte
- Formschönes, ovales Zentralprofil
- Einseitige Ausführung mit seitlichen, in der Höhe verstellbaren Prospektboxen
- Doppelseitige Ausführung mit seitlichen, schräg montierten Prospektboxen
- Neutrales Topschild für permanentes Branding

- *Single or double face brochure stand for 8 x DIN A4 size*
- *Eye-catching central pole with lateral*
- *Singe Version with height adjustable brochure boxes*
- *Double Version with aslope fixed brochure boxes*
- *Neutral header for permanent branding*



Top-Schild
UFSL120100X1000
für Prospektständer mit Zentralprofil



Prospekt-Dispenser
UFSL120000X1000
DIN A4 Wand-Prospektdispenser

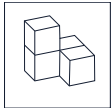

Art.-Nr.	Format	Beschreibung
1300005	8 x DIN A4 hoch	Einseitig
1300006	8 x DIN A4 hoch	Doppelseitig



Einseitige Version
Single sided version



Doppelseitige Version
Double sided version

Variation 70 Plakat-Prospektständer | Variation 70 poster stand

- Kombination von Plakat- und Prospektpräsentation
- Ein- oder doppelseitig lieferbar
- Stabile Bodenplatte mit Bodengleitern
- Ovale, silberfarbenes eloxiertes Zentralrohr
- 25 mm Klapprahmen im DIN A1 Format
- Prospektablage aus Acryl oder Metall (für 2 DIN A4 Prospekte im Hochformat)

- *Combination of poster- and brochure stand*
- *Available single- or double sided*
- *Stable base plate with floor gliders*
- *Oval, silver-colored anodized central tube*
- *25 mm snapframe, Format DIN A1*
- *Brochure shelf made of acrylic glass or metal (for 2 DIN A4 leaflets)*

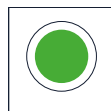
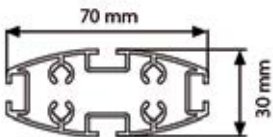
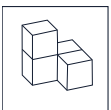

Prospekt-Ablage UFSL0023A4X5000
3 x DIN A4 Metall Prospektablage in Lochblech-Optik



Prospekt-Ablage UFSL003000X1000
2 x DIN A4 Acryl-Prospektablage für Prospektständer mit Zentralprofil



Prospekt-Ablage UFSL002000X1000
2 x DIN A4 Metall-Prospektablage für Prospektständer mit Zentralprofil



Art.-Nr.	Plakatformat (mm)	Profil	Prospektablage
1300007	594 x 841	25 mm, Gehrung	Acryl 2 x DIN A4
1300008	594 x 841	25 mm, Gehrung	Stahl 2 x DIN A4
1300019	594 x 841	25 mm, Gehrung	Stahl 3 x DIN A4

Bannerständer Variation 70 | *Variation 70 banner stand*

- Kombination aus Banner- und Prospektständer
 - Stabile Bodenplatte mit Bodengleitern
 - Ovales Zentralrohr mit 4 Systemnuten
 - 600 mm Banner-Abhängeschiene
 - 4 seitliche Prospektboxen für DIN A4 Prospekte
- *Banner Display with brochure presentation*
 - *Stable base plate with floor gliders*
 - *Elliptic central upright with 4 inbuilt grooves*
 - *600 mm Banner suspension profile*
 - *4 lateral brochure boxes for DIN A4 leaflets*

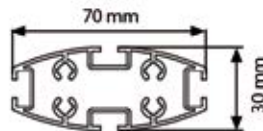
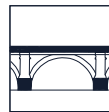
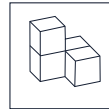
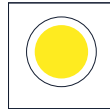

Art.-Nr.	Bannerformat (mm)	Prospektablage
1300009	600	Acryl 4 x DIN A4

Variation 70 Prospektständer | *Variation 70 brochure stand*

- Ein- oder doppelseitiger Prospektständer für je 2 x DIN A4 Prospekte nebeneinander
 - Ovales Zentralprofil mit Acrylglas- oder Stahlblech-Prospektablagen
 - Neutrales Topschild für permanentes Branding
- *Single- or double sided brochure stand for 2 x DIN A4 portrait format*
 - *Elliptic central upright with acrylic or steel shelves*
 - *Neutral header for permanent branding*

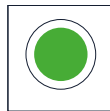
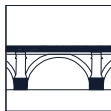
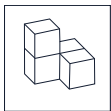

Art.-Nr.	Ausführung	Ablage	Format
1170018	einseitig	Acryl	8 x DIN A4
1170019	doppelseitig	Acryl	16 x DIN A4
1170020	einseitig	Stahlblech	8 x DIN A4
1170021	doppelseitig	Stahlblech	16 x DIN A4



Variation Modulsystem | *Variation modular stands*



Art.-Nr.	Beschreibung	Abmessungen Plakatmaß (mm)
UFSL001200X2000	Ovales Zentral-Profil mit Bodenplatte	1920
UFSL0000A4X2000	Klapprahmen 25 mm, Gehrung	DIN A4
UFSL0000A3X2000	Klapprahmen 25 mm, Gehrung	DIN A3
UFSL0000A2X2000	Klapprahmen 25 mm, Gehrung	DIN A2
UFSL0000A1X2000	Klapprahmen 25 mm, Gehrung	DIN A1
UFSL0000B2X2000	Klapprahmen 25 mm, Gehrung	500 x 700
UFSL0000B1X2000	Klapprahmen 25 mm, Gehrung	700 x 1000
UFSL003000X1000	Acryl-Prospektablage	2 x DIN A4
UFSL002000X1000	Stahl-Prospektablage	2 x DIN A4
UFSL110000X1000	Banner Abhänge Set	400
UFSL110100X1000	Banner Abhänge Set	500
UFSL110200X1000	Banner Abhänge Set	600
UFSL110300X1000	Banner Abhänge Set	700
UFSL140000X1000	Prospektablage auf Alu-Profil	DIN A4
UFSL140100X1000	Prospektablage auf Alu-Profil	DIN A5
UFSL140200X1000	Prospektablage auf Alu-Profil	DIN Lang
UFSL120200X1000	Top-Schild	450 x 160
UFSL120000X1000	Prospektbox	DIN A4
UFSL130300X1000	Einschubrahmen	DIN A4
UFSL130200X1000	Einschubrahmen	DIN A3
UFSL130100X1000	Einschubrahmen	DIN A2

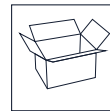
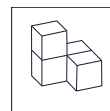

Tisch-Prospektdispenser | *Leaflet Dispensers*

- Prospektdispenser aus glasklarem Polystyrol
- Für freistehende Aufstellung auf Tisch oder Theke
- Erhältlich in den Formaten DIN Lang, DIN A5 und DIN A4 sowie
- Mit Trennsteg auch für 2 x DIN Lang
- Logo-Siebdruck auf Anfrage

- *Brochure holders made from clear polystyrene*
- *Freestanding on table or counter*
- *Available in 1/3 DIN A4, DIN A5, DIN A4*
- *With T-separator also for 2 x 1/3 DIN A4 size*
- *Branding of brochure holders on request*



UYUP449601X1001
Trennsteg für DIN A4
T-separator for DIN A4 size

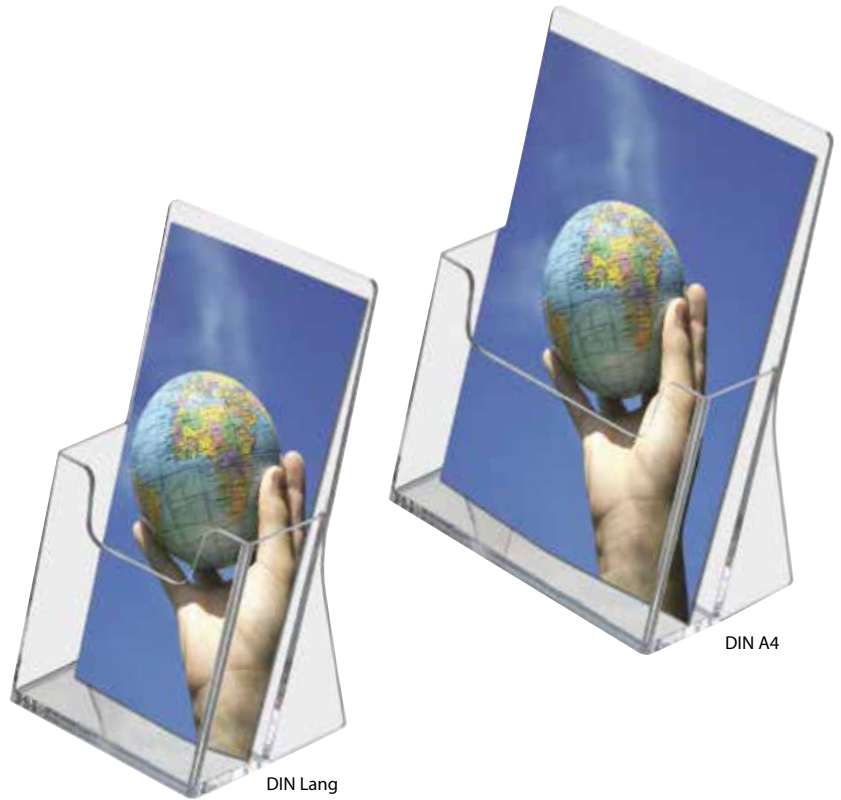
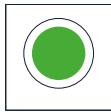

Art.-Nr.	Format (DIN)	Druckbereich (mm)	Beschreibung	VPE
UMSD001005X1001	A4	40 x 90	Hochformat	20
UMSD001004X1001	A5	55 x 140	Hochformat	40
UMSD001003X1001	DIN Lang	70 x 200	Hochformat	50
UYUP449601X1000	A4		Trennsteg	20

Mehrfach Prospektdispenser | *Multiple Pocket Leaflet Dispensers*

- Prospektdispenser aus glasklarem Polystyrol
- Für freistehende Aufstellung auf Tisch oder Theke
- Erhältlich in den Formaten 3 x DIN Lang, 4 x DIN Lang, 3 x DIN A5 und 3 x DIN A4
- Logo-Siebdruck auf Anfrage

- *Brochure holders made from clear polystyrene*
- *Freestanding on table or counter*
- *Available in 3 x 1/3 DIN A4, 4 x 1/3 DIN A4, 3 x DIN A5, 3 x DIN A4*
- *Branding of brochure holders on request*

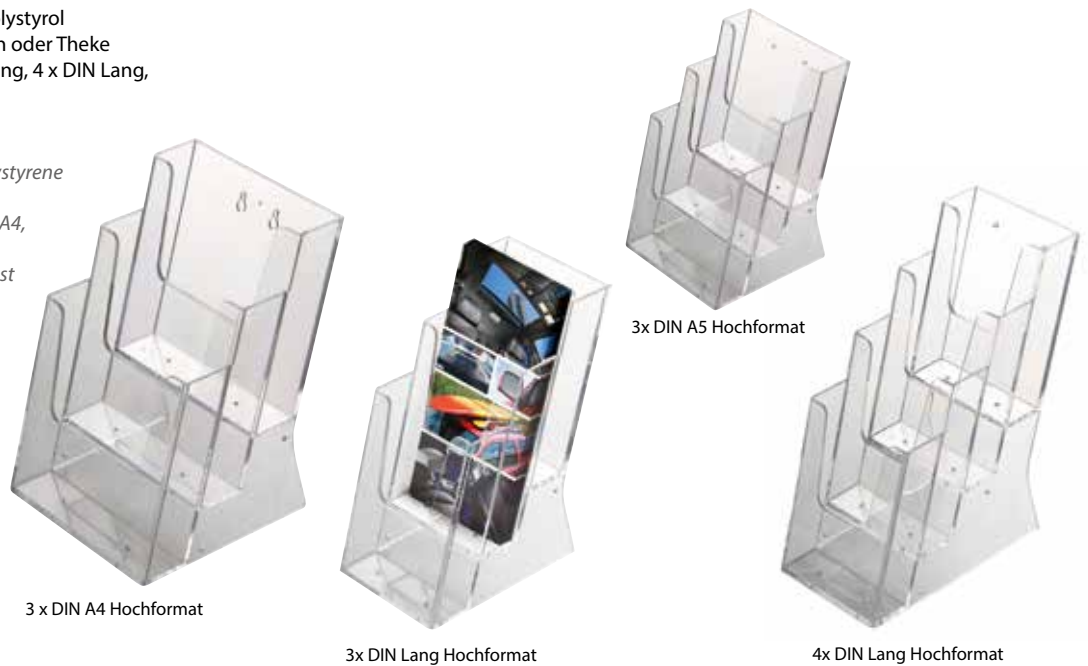

Art.-Nr.	Format (mm)	Beschreibung	VPE
UMSD003000X1000	210 x 297	3 x DIN A4 Hochformat	4
UMSD003050X1000	105 x 210	4 x DIN Lang Hochformat	18
UMSD004000X1000	148 x 210	3 x DIN A5 Hochformat	12
UMSD005000X1000	105 x 210	3 x DIN Lang Hochformat	20

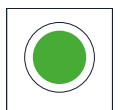

Textil-Spannrahmen MaxiFrame | *Textile Stretchframe MaxiFrame*

- Einseitig oder doppelseitig bespannbarer Textilrahmen
- Verschiedene Bautiefen erhältlich
- Verschiedene Größen auf Anfrage erhältlich
- Erhältlich als Stand- oder Wandversion oder zur Deckenabhängung
- Versteifung durch H-Profil möglich
- Kleinere Formate eignen sich gut zur Wandmontage
- Demontierte Lieferung

- *Single-sided oder double-sided textile stretchframe*
- *Different construction depth available*
- *Different sizes available on request*
- *Available as stand or wall version or for ceiling suspension*
- *Stabilization by H-profile possible*
- *Small sizes are ideal for wall mounting*
- *Disassembled delivery*

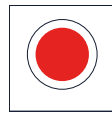
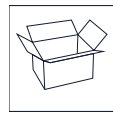

Circle Fuß



Baseball Fuß



Fillet Fuß

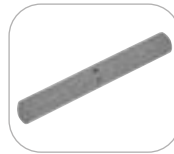

T- Fuß



Hoop Fuß



Drahtseil Abhängeset



Art.-Nr.	Produkt	Außenmaß (mm)	Gewicht (kg)
UYUP412274X1000	Fillet Fuß	500 x 180 x 6	3,3
UYUP412271X1000	Circle Fuß	∅ 450 x 6	7,5
UYUP412273X1000	Baseball Fuß	450 x 300 x 6	4,7
UYUP412272X1000	Hoop Fuß	∅ 450 x 6	4,4
UYUP412275X2000	T- Fuß	450 x 50 x 5	4,0
UYUP460245X1000	Drahtseil Abhängeset		

Weitere Informationen auf Anfrage / More informations on request

Textil-Spannrahmen MaxiFrame LED | *Textile Stretchframe MaxiFrame LED*

- Einseitig oder doppelseitig bespannbarer LED Textilrahmen
- Brillante Ausleuchtung durch LED-Flächenlicht
- Verschiedene Bautiefen erhältlich
- Verschiedene Größen auf Anfrage erhältlich
- Erhältlich als Stand- oder Wandversion oder zur Deckenabhängung
- Textildruck leicht austauschbar
- Einfache Montage mit Steckverbindern
- Optional mit Smart Home Steuerung
- Kleinere und mittlere Formate eignen sich gut zur Wandmontage.
- Doppelseitige Rahmen eignen sich gut zur Deckenabhängung oder als Standmodell
- Demontierte Lieferung

- *Single-sided oder double-sided LED textile stretchframe*
- *Bright and even illumination by LGP*
- *Different construction depth available*
- *Different sizes available on request*
- *Available as stand or wall version or for ceiling suspension*
- *Easy change of textile prints*
- *Easy assembly with plug connectors*
- *Optionally with Smart Home control*
- *Small and medium sizes are ideal for wall mounting.*
- *Double-sided frames are ideal for ceiling suspension or as a free-standing model*
- *Disassembled delivery*

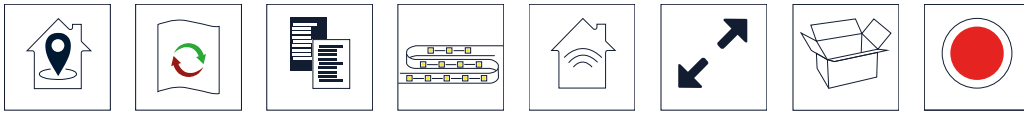

Weitere Informationen auf Anfrage / More informations on request

Textil-Spannrahmen MaxiFrame Wood/LED | *Textile Stretchframes MaxiFrame Wood/LED*

- Einseitig bespannbarer Textilrahmen aus Holz
- Dekoratives Highlight in jeder Raum- oder Shopgestaltung oder auch im privaten Bereich
- Verschiedene Bautiefen und Größen erhältlich
- Erhältlich in Buche- oder Eiche Vollholz, Nuss- oder Ahorn-Echtholz
- Integrierte Nut für Flachkeder
- Textildruck leicht austauschbar
- Demontierte Lieferung
- Version mit LED-Beleuchtung auf Anfrage

- *Single-sided textile stretchframe made by wood*
- *Decorative highlight in any room or shop design or private area*
- *Different construction depths and sizes available*
- *Made of beech wood or solid oak wood, also available in walnut or maple real wood*
- *Inbuilt groove for silicone lip*
- *Easy change of textile prints*
- *Disassembled delivery*
- *LED illuminated version upon request*

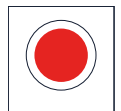
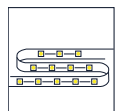
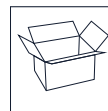

Weitere Informationen auf Anfrage / More informations on request

Falt-Prospektständer Stehpult | Foldable Counter Standing Desk

- Robuster Falt-Prospektständer in modernem Design!
 - Platz für 6 x DIN A4 Prospekte im Hochformat oder 3 x DIN A3 Prospekte im Querformat
 - Ideal als Rednerpult oder Messetheke
 - Tischplatte in schwarz oder Buche Dekor
 - Tragetasche aus Nylon mit Styropor-Innenauskleidung
 - Optional auch erhältlich komplett in weiß
- Robust folding counter in a modern design!
 - Takes 6 x DIN A4 brochures in portrait format or 3 x DIN A3 brochures in landscape format
 - Table top allows use as speakers desk or exhibition counter
 - Table top in black or beech decor
 - Nylon carrying case with inner reinforcement for protection
 - Optionally also available completely in white colour

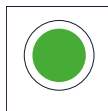
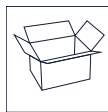

Art.-Nr.	Farbe	Tischplatte	Format
UWFH1D1324X5000	Schwarz	Buche Dekor	6 x DIN A4
UWFH1B1324X5000	Schwarz	Schwarz	6 x DIN A4
UWFH1B0314X5000	Schwarz	Schwarz	3 x DIN A4

Promotion-Theke | Promostand

- Einfache und preiswerte Kunststoff-Theke
- Faltbarer Korpus mit tiefgezogener Boden- und Deckelplatte sowie Zwischenboden
- Inkl. Logo-Aufsatz und Tragetasche
- Grafikproduktion auf Anfrage

- *Simple and low-cost counter produced in white plastic*
- *Foldable and easy to transport and mount*
- *Comes with top, shelf and header, transport bag optionally*
- *Graphic production on request*



Art.-Nr.	Beschreibung	Maße (mm)	Breite Thekenplatte (mm)
UTS00N5100X1000	mit Transporttasche	510 x 2200	900

Falttheke Konvex / Falttheke Midsize Konvex | Convex Panset Counter/ Midsize Convex Counter

- Falttheke aus Alu-Zahnkranzprofil und weißen PVC-Leichtschamplattens
- Deckelplatte wahlweise weiß oder in Buchenholzdekor
- Zwischenboden aus weißem Kunststoff
- Nylon-Tragetasche optional
- Ausführung mit Bar-Aufsatz auf Anfrage

- *Folding counter, combination of aluminium gearing profile and PVC foam sheets*
- *Top-plate either white or beech wood-look*
- *Shelf made of white PVC*
- *Nylon carry-on bag optional*
- *Version with bar-top on request*



UYUP070200X1000
Nylon-Tragetasche für
Konvex /Midsize Konvex
Falttheke

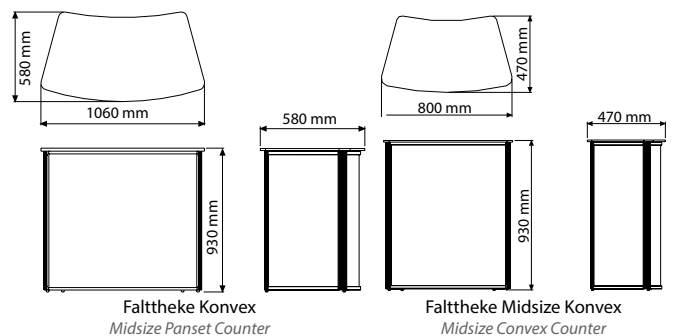

Art.-Nr.	Modell	Plattenmass (mm)
UPSM002000X1000	Konvex - Weiße Deckelplatte	878 x 980 / 878 x 430
UPSM008000X1000	Konvex - Buche Deckelplatte	878 x 980 / 878 x 430
UPSM052000X1000	Midsize - Weiße Deckelplatte	800 x 930 x 470
UYUP074000X1000	Tragetasche für Konvex Falttheke	
UYUP070200X1000	Tragetasche für Midsize Falttheke	
Art.-Nr.	Beschreibung	
3254031	Druck für Konvex Theke	
3254002	Druck für Midsize Konvex-Theke auf 3 mm Hartschaum	787 x 878 x 335

Quattro Falttheke | Square Counter

- Kompakte Viereck-Theke
- Tischplatte in Holzoptik
- Weißer Zwischenboden
- Einfacher Aufbau ohne Werkzeug
- Inkl. Nylon-Transporttasche mit Tragegriffen

- *Elegant square counter*
- *Table top in wood look*
- *White intermediate shelf*
- *Easy Set up without tools*
- *Incl. Nylon carrying bag with carrying handles*



Nylon-Transporttasche für Quattro Falttheke
Nylon carrying bag for square counter

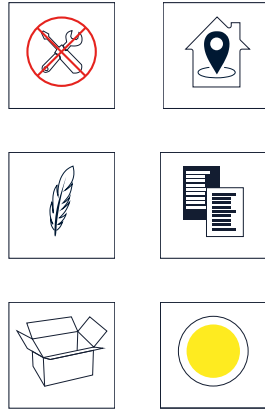

Art.-Nr.	Modell	Format (mm)
UPSM010000X5013	Holz Deckelplatte	374 x 877 x 360 mm
Art.-Nr.	Beschreibung	
3254030	Druck Quattro-Falttheke	

Sechseck Falttheke | Hexagonal Panset Counter

- Falt-Theke mit viel Stauraum für Kataloge
- Alu-Zahnkranzprofil mit weißen Leichtschaum-Paneelen
- Deckelplatte wahlweise aus weißem Kunststoff oder in Buchenholzdekor
- Zwischenboden aus weißem Kunststoff
- Nylon-Tragetasche optional und Grafikproduktion auf Anfrage

- *Folding counter with large space for catalogues and equipment*
- *Made of aluminium profiles and white PVC-foam*
- *Top-plate available in white PVC-foam or beech wood design*
- *Shelf made of white PVC-foam*
- *Nylon carry-on bag optionally and graphic production on request*



UYUP074100X1000
Nylon-Tragetasche für Sechseck Falttheke
Nylon carrying bag for hexagonal panset counter



Art.-Nr.	Beschreibung	Plattenmaß BxH (mm)
UPSM001000X1000	Theke mit weißer Deckelplatte	659 x 878 / 311 x 878
UPSM007000X1000	Theke mit Buche-Deckelplatte	659 x 878 / 311 x 878
UYUP074100X1000	Tragetasche	
3254018	Druck Sechsecktheke	

MaxiFrame LED GO | MaxiFrame LED GO



- Mobiles Leuchtdisplay mit hoher Leuchtkraft und gleichmäßiger, schattenfreier Ausleuchtung
 - Das System wird demontiert geliefert und dank spezieller Eckverbinder mit ein paar Handgriffen werkzeuglos aufgebaut
 - Magnetisches Verbindungssystem erlaubt die Erweiterung mehrerer Elemente zu einem großflächigen System
 - Bautiefe 80 mm
 - Robuste Transportverpackung mit Tragegriff
 - Gepolsterte Tragetasche inklusive
- *Mobile illuminated display with bright and even illumination due to lateral mounted*
 - *The system comes knocked down and thanks to special corner connectors, the set up without tools is made in a few simple steps*
 - *Magnetic connection system allows the extension of several elements into a large-area graphic system*
 - *Depth 80 mm*
 - *Robust transport packaging with carrying handle*
 - *Comes with padded carry-on bag*

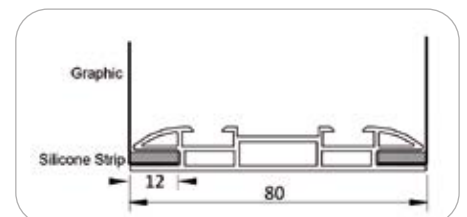
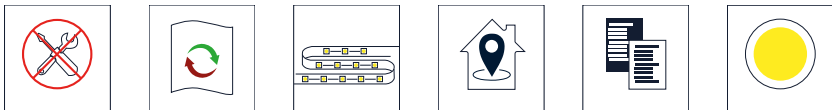

Art.-Nr.	Ausführung	Format (mm)
1240120	ohne Druck	1000 x 2000

Roll Banner Budget | *Roll Banner Budget*

- Rolldisplay für eine kostengünstige Präsentation
 - Das Banner wird oben geklemmt und unten geklebt
 - Stabiler Stand durch zwei Stellfüße
 - Nylon-Tragetasche mit Schulterriemen
 - Made in Europe
- *Competitive Roll-Up display with 2 flexible legs*
 - *Top profile with clamp system and double-sided tape on the bottom*
 - *Stable stand thanks to two adjustable feet*
 - *Nylon-bag with shoulder strap*
 - *Made in Europe*

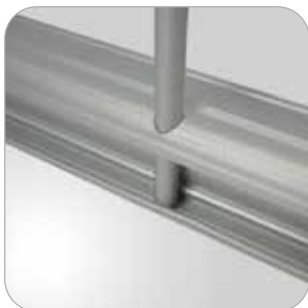
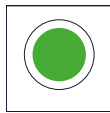

Art.-Nr.	Sichtmaß (mm)	Ausführung	Bannermaß (mm)
1259023	850 x 1970	ohne Druck	850 x 2000
1259024	1000 x 1970	ohne Druck	1000 x 2000
1259025	850 x 1970	mit Druck	850 x 2000
1259026	1000 x 1970	mit Druck	1000 x 2000

Smart Roll Banner | Smart Roll Banner

- Einseitiges Roll-Up Display
 - Banneraufsteller mit Kassette aus Aluminium
 - Bannerhöhe kann zwischen 1000 und 2300 mm eingestellt werden
 - Banner-Klemmleisten für einfachen Wechsel der Banner
 - Nylon-Trageköcher mit Papphülse
 - Made in Europe
 - Andere Größen auf Anfrage erhältlich
-
- Roll Banner display, single-sided
 - Silver anodised aluminium case
 - Height of banner adjustable from 1000 to 2300 mm
 - Easy change of banners by special banner-clamps
 - Comes with nylon cartridge
 - Made in Europe
 - Other sizes available on request

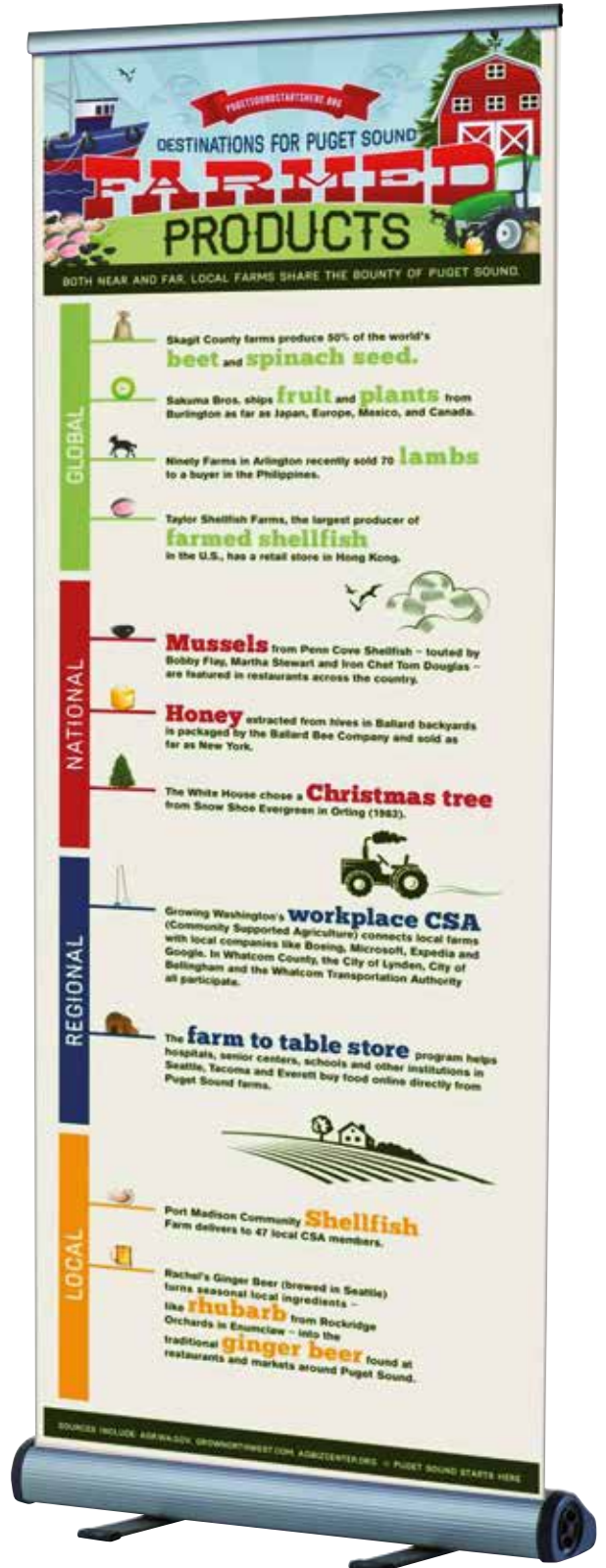
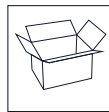

Art.-Nr.	Breite (mm)
URBST00N00X5000	600
URBST00N00X5010	700
URBST00N82X2000	800
URBST00N00X5011	850
URBST00N12X2000	1000
URBST00N00X5001	1500

NEU! Textil-Spannrahmen MaxiFrame LED FOLD | *NEW! Textile Stretchframe MaxiFrame LED FOLD*

- **Weltneuheit!**
- Geschützter LED Textil-Spannrahmen – sekundenschnell aufgebaut durch Faltechnik in Kombination mit einer Gelenkfunktion
- Ein- oder doppelseitig nutzbar
- Nur 85 mm Bautiefe
- Optional mit seitlicher Magnettechnik um mehrere Rahmen fest aneinander stellen zu können und ein Großbild zu erzeugen

- **World novelty!**
- *Protected LED textile frame - set up in seconds using folding technology in combination with a hinge function*
- *Can be used on one or both sides*
- *Only 85 mm construction depths*
- *Optionally with lateral magnet technology in order to be able to place several frames firmly next to each other and to create a large image*

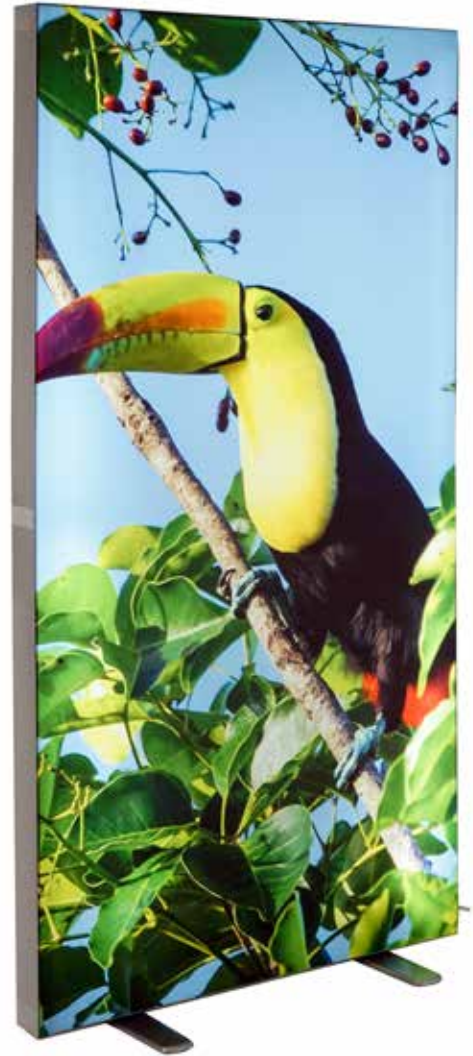
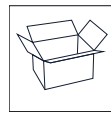
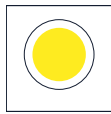
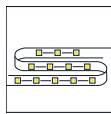

Art.-Nr.	Grafikmaß (mm)
1240141	1000 x 2000

Außen-Leuchtkästen | *Outdoor Lightbox*

- Rahmen aus silberfarbigen Alu-Hohlkammerprofilen
 - Ausführung mit opaler Haube, eingelegter Opalscheibe oder Aluminium-Klapprahmen
 - Erhältlich als einseitige Wandversion oder doppelseitiges Auslegertransparent
 - Bedruckung gemäß Vorgabe
 - Ausleuchtung durch unterschiedliche LED Techniken, abhängig von Größe und Einsatzzweck
 - Montage durch einen konzessionierten Elektrobetrieb auf Anfrage
-
- *Frame made of silver-colored aluminum hollow profile*
 - *Optionally with cap, flat opal glass or aluminum snap-frame*
 - *Single-sided or double-sided version*
 - *Printing according to specification*
 - *Illumination by different LED techniques, depending on size and purpose*
 - *Installation by a licensed electric company on request*

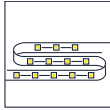

Weitere Informationen auf Anfrage / *More informations on request*

LED Leuchtrahmen Outdoor 35 mm | LED lightframe Outdoor 35 mm

- Wasserfester Leuchtrahmen
 - Verschließbare 35 mm Klemmprofile, silber eloxiert
 - Bautiefe 29 mm
 - IP 67 Netzteil
 - Übergroße Schutzfolie und umlaufende Dichtung auf dem Unterprofil
 - LED's in Silikon eingeklebt
 - Maximalformat 1900 x 1000 mm
- *Waterproof LED snapframe*
 - *Lockable 35 mm snap profiles*
 - *Construction depth 29 mm*
 - *IP 67 power supply*
 - *Oversized protective film and seal on back profile*
 - *LED glued in silicone*
 - *Maximum format 1900 x 1000 mm*

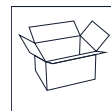
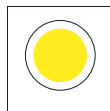
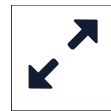
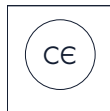
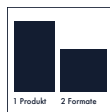
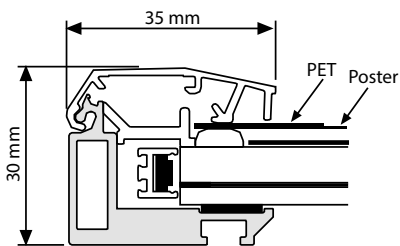
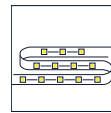

Art.-Nr.	Plakatmaß (mm)	Ausleuchtung (Lux)	Watt
ULH35TNOA2X2000	420 x 594	2100	23
ULH35TNOA1X1000	594 x 841	1900	35
ULH35TNOA0X1000	841 x 1189	1500	48
ULH35TNOB2X1000	500 x 700	1900	27
ULH35TNOB1X1000	700 x 1000	1700	41
ULH35TNOB0X1000	1000 x 1400	1500	58



Gestell nicht im Lieferumfang enthalten!
Frame not included in delivery!

InfoSign OUTDOOR | InfoSign OUTDOOR



- Freistehendes Rasenschild
- Konstruktion aus verwindungssteifen L-Profilen aus Stahl, RAL 9005 schwarz pulverbeschichtet
- Ideal als Immobilien, Willkommens, Warn, Werbe- oder Parkplatzschild
- Bedruckte PVC Schaum- oder Alu- Verbundplatten werden von hinten verschraubt (nicht im Lieferumfang enthalten)
- Ständer wird einfach mit der Spitze in die Erde gesteckt

- *Free-standing lawn sign*
- *Construction made of torsion-resistant L-profiles made of steel, RAL 9005 powder-coated*
- *Ideally suited as a real estate, welcome, warning, advertising or parking lot sign*
- *Printed PVC foam or aluminum composite panels are screwed on from behind (not included in delivery)*
- *The stand is simply stuck with the tip into the ground*

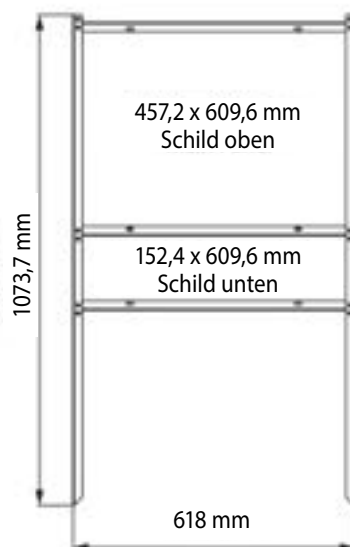
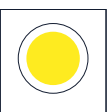
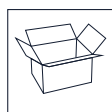
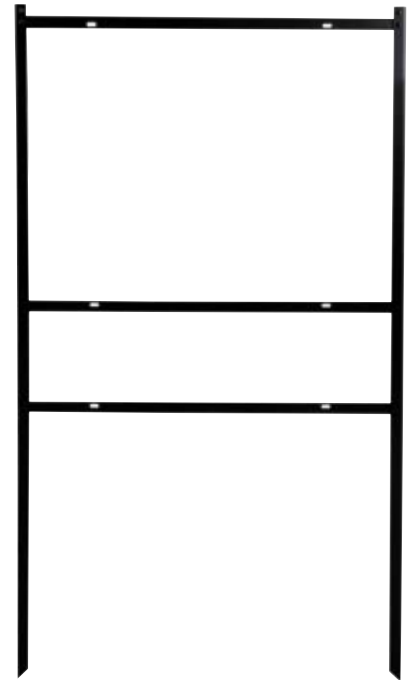

Andere Versionen auf Anfrage.
Other versions in on request.

Art.-Nr.	Abmessung Schild oben (mm)	Abmessung Schild unten (mm)
URESBOH124X2000	457,2 x 609,6	152,4 x 609,6

Mobile Arbeitsstation BLACK | Mobile Workstation BLACK

- Sehr variabel einstellbare Arbeitsstation
- Moderne, schwarze Optik
- Höhenverstellbares Gestell
- Computer Ablage aus schwarzem Stahlblech
- Tastatur- und Bildschirm Ablage in der Höhe verstellbar
- Mobil durch Laufrollen mit Feststell-Bremse

- *Very variably adjustable workstation*
- *Modern black look*
- *Height adjustable legs*
- *Computer shelf made of black steel sheet*
- *Keyboard- and screen shelf height adjustable*
- *Mobile thanks to castors with brake*

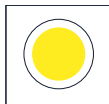
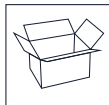

Art.-Nr.	Abmessung (mm)
UAWSB00010X2000	520 x 785/1235 x 600

Mobiles Stehpult BLACK | Mobile Podium BLACK

- Sehr variabel einstellbares Stehpult
- Moderne, schwarze Optik
- Höhenverstellbares Gestell
- Ablage aus schwarzem Stahlblech, in der Höhe verstellbar
- Pult in der Neigung verstellbar
- Mobil durch Laufrollen mit Feststell-Bremse

- *Very variably adjustable podium*
- *Modern black look*
- *Height adjustable legs*
- *Shelf made of black steel sheet*
- *Desk adjustable in inclination*
- *Mobile thanks to castors with brake*

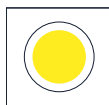
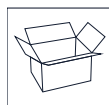

Art.-Nr.	Abmessung (mm)
UMWSB00010X2000	630 x 450 x 780/1230

Drehbare Fußstütze, dynamisch | Rotatable Footrest, dynamic

- Ergonomische Fußablage für eine gesunde Körperhaltung und bessere Durchblutung
 - Dient als feste Auflage oder kann mit Schaukelfunktion genutzt werden
 - Massiver ABS-Kunststoff
 - Perfekt für Büro oder Home Office
 - Drehbar und dann einsetzbar in 2 Positionen
 - Gummiprofil als Rutschsicherung und Schutz des Bodens vor Kratzern
 - Einzelverpackt im Karton
- *Ergonomic footrest for a healthy posture and better blood circulation*
 - *Serves as fix support or with rocking function*
 - *Solid ABS plastic*
 - *Perfect for office and home office*
 - *Rotatable and then usable in 2 positions*
 - *Anti-slip rubber profile also for floor protection*
 - *Individual carton*

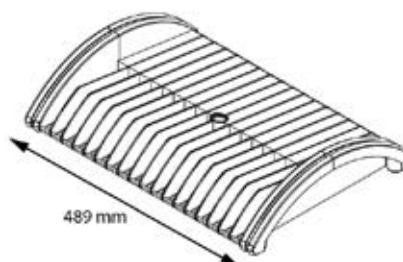
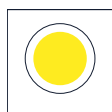
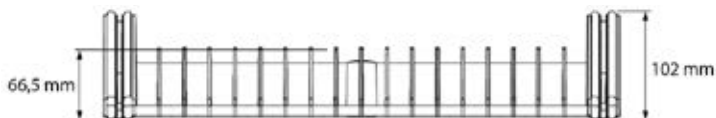
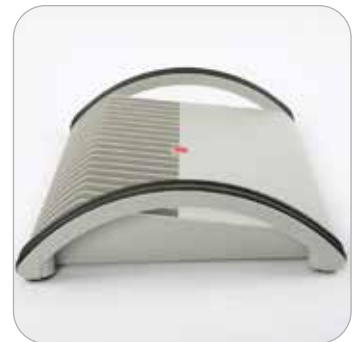

Art.-Nr.	Farbe	Abmessung
UAFRG00000X2000	grau	489 x 102 x 66,5 mm

NEU! Universale Monitorerhöhung | *NEW! Universal Monitor Stand*

- Erhöhung für Computermonitore im ergonomischen Design
 - Verbessert die Körperhaltung, da Ihr Bildschirm auf einer angenehmeren Augenhöhe steht
 - Rutschfest durch transparente Pads
 - Material: Stahl
 - Strukturierte Oberfläche
 - Schwere und stabile Ausführung, max. Tragkraft 14 kg
 - Erhältlich in den Farben grau, schwarz und weiß
- *Elevator for computer monitors in ergonomic design*
 - *Improves posture by placing your screen at a more comfortable eye level*
 - *Soft feet/ Non-slip thanks to transparent pads*
 - *Steel: material*
 - *Textured finish*
 - *Heavy sturdy design, carriage capacity 14 kg*
 - *Available in grey, black and white*



Art.-Nr.	Farbe	Abmessung (mm)	VPE
UUMS01N000X2000	Grau	400 x 210 x 48	2
UUMS01B000X2000	Schwarz	400 x 210 x 48	2
UUMS01W000X2000	Weiß	400 x 210 x 48	2



Tastaturablage | *Keyboard Tray*

- Ergonomische Tastaturablage für bequemes Arbeiten
 - Rutschfest durch transparente Gummi-Füße und Gummiprofil
 - Verwendbar für fast alle Tastaturen
 - Glänzend polierte Kanten
 - UV-beständiges, glasklares Acrylglas
- *Ergonomic keyboard tray for comfortable work*
 - *Non-slip thanks to transparent rubber feet and rubber profile*
 - *Suitable for almost all keyboards*
 - *Shiny polished edges*
 - *UV-resistant, crystal clear acrylic glass*

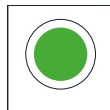
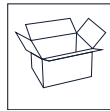

Art.-Nr.	Ausführung	Format (mm)
UMSKBS0017X2000	Tastatur Ablage	432 x 42 x 155 mm



Wand-Prospektdispenser | Wall Mounted Leaflet Dispensers



- Prospektdispenser aus glasklarem Polystyrol für die Wandmontage
- Erhältlich in den Formaten DIN Lang, DIN A5 und DIN A4
- Logo-Siebdruck auf Anfrage
- Version mit Klappdeckel ist für Außeneinsatz geeignet
- *Clear polystyrene dispenser for wall mounting*
- *Available in 1/3 DIN A4, DIN A5 and DIN A4*
- *Logo printing on request*
- *Version with hinged cover is suitable for outdoor use*

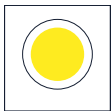

DIN Lang



Erhältlich in DIN A5 und DIN A4

Available in DIN A5 and DIN A4



DIN A5

Art.-Nr.	Anwendung	Format (DIN)	VPE
UMSD006000X1000	Inneneinsatz	DIN Lang	60
UMSD007000X1000	Inneneinsatz	A5	45
UMSD008100X2000	Inneneinsatz	A4	30

Visitenkartenbox | Business Card Holder



- Visitenkartenständer aus glasklarem Polystyrol
- *Business card holders made from clear polystyrene*



Art.-Nr.	Farbe	Abmessungen (BxHxT)	VPE
UMSD009000X1000	Transparent	95 x 55 x 39	40

Transporthilfe für WindPro® | Carry Tool for WindPro®

- Transporthilfe für WindPro® Kundenstopper
- Zugkraft mx. 6-8 kg

- Carry tool for WindPro® A-Boards
- Pulling force 6-8 kg max.

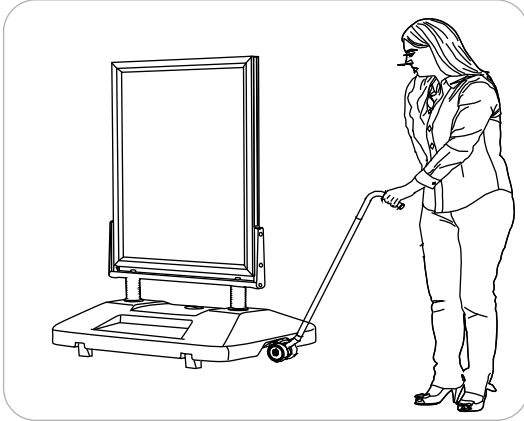

Art.-Nr.
UYUP480945X1000

Netzteile | Power Supplies

- Ersatzladekabel/Netzteil
- Power Supply/Charger



Art.-Nr.	Leistung	für Format einseitig	für Format doppelseitig
UYUP445440X1000	1 Ampere	DIN A4	
UYUP445450X1000	2 Ampere	DIN A3	DINA4 + DIN A3
UYUP445460X1000	3 Ampere	DIN A2	DIN A2
UYUP445490X1000	4 Ampere	DIN A1 / 700 x 1000 mm	DIN A1
UYUP445510X1000	5 Ampere	DIN A0	700 x 1000 mm
UYUP445520X1000	6 Ampere	1000 x 1400	

Schreibfolie DIN A1 | *Write-on film DIN A1*

- Schreibfolie
- PVC
- 0,4 mm stark
- DIN A1 Format
- *Write-on film*
- *PVC*
- *0,4 mm thick*
- *DIN A1 format*



Art.-Nr.	Farbe
6100001	Schwarz

Prospektkorb, DIN A4 | *Brochure basket, DIN A4*

- Prospektkorb DIN A4 für Kundenstopper Classic, für Traverse
- *DIN A4 brochure basket for A-Board Classic to hang on scissors*



Art.-Nr.	Format (DIN)
UYTS3000A4X1000	A4

Deckenabhängeset/Stahlseil | *Steel wire ceiling suspension set*

- 2 x Stahlseil
- 1,5 mm stark
- Verzinkt
- *2 x steel cable*
- *12,5 mm thick*
- *Galvanized*



Art.-Nr.	Beschreibung
2100005	für doppels. Klapprahmen DIN A4, inkl. Schienengleiter
2100002	für Leuchtkasten, inkl. Bilderhaken "Fixmatic"
2100001	für Klapprahmen, inkl. verstellbaren Bilderhaken

Topschild | *Header*

- Topschild für Kundenstopper
- *Header for pavement signs*

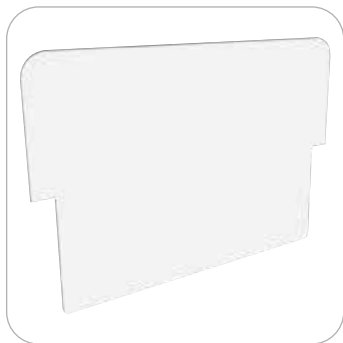

Art.-Nr.	Format (DIN)
UYFT0000A2X1000	A2
UYFT0000A1X1000	A1
UYFT0000A0X1000	A0
UYFT0000B2X1000	B2
UYFT0000B1X1000	B1

Topschild | *Header*

- Topschild für Kundenstopper WindPro®
- *Header for pavement sign WindPro®*



Art.-Nr.	Format (DIN)
UYFT0030A1X1000	A1
UYFT0030A0X1000	A0
UYFT0030B2X1000	B2
UYFT0030B1X1000	B1

Aufsatzhalterung für Topschild | *Pavement sign wire header holder*

- Verwendbar für viele Kundenstopper
- Sorgt für die Standfestigkeit des Topschildes
- *Usable for many pavement signs*
- *Ensure the stability of the top shield*

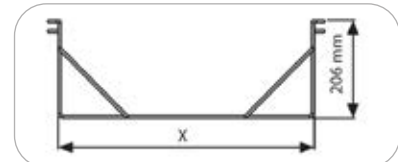
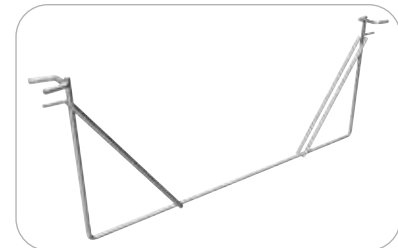

Art.-Nr.	Format (DIN)	X
UYTT0000A2X1000	A2	405 mm
UYTT0000A1X1000	A1	579 mm
UYTT0000A0X1000	A0	826 mm
UYTT0000B2X1000	B2	485 mm
UYTT0000B1X1000	B1	685 mm

Wasserfeste Folientasche für Kundenstopper |

Waterproof poster packet for pavement signs

- Wasserfeste Folientasche **für Kundenstopper**
- PET Tasche aus 2 Schutzfolien mit umlaufender Dichtung
- *Waterproof poster pocket for pavement signs*
- *PET pocket made of 2 PET sheets and circumferential seal*



Art.-Nr.	Format	Folie (mm)
UYUP088100X5279	DIN A1	613 x 860
UYUP088100X5280	DIN A0	860 x 1208
UYUP088100X5305	DIN B1	719 x 1019

Wasserfeste Folientasche für Klapprahmen |

Waterproof poster packet for snap frames

- Wasserfeste Folientasche **für Klapprahmen**
- *Waterproof poster pocket for snap frames*



Art.-Nr.	Format	Plakatformat (mm)
6100107	DIN A4	210 x 297
6100106	DIN A3	297 x 420
6100108	DIN A2	420 x 594
6100105	DIN A1	594 x 841

Antireflex Schutzfolie, B1 zertifiziert |

Antireflex cover-sheet, B1 certification

- Antireflex Schutzfolie
- **Für FireProtection Klapprahmen**
- B1 zertifiziert
- *Antireflex cover-sheet*
- *For FireProtection snap frames*
- *B1 certification*



Art.-Nr.	Format	Plakatformat (mm)
UYUP033020X2000	DIN A4	210 x 297
UYUP033030X2000	DIN A3	297 x 420
UYUP033040X2000	DIN A2	420 x 594
UYUP033010X2000	DIN A1	594 x 841
UYUP033050X2000	DIN A0	841 x 1189
UYUP033060X2000	DIN B2	500 x 700
UYUP033070X2000	DIN B1	700 x 1000
UYUP033080X2000	DIN B0	1000 x 1400

Antireflex Schutzfolie für wasserfeste Klapprahmen |

Antireflex cover-sheet for waterproof snap frames

- Antireflex PET Schutzfolie
- **Für wasserfeste Klapprahmen 25 mm**
- *Antireflex PET cover-sheet*
- *For waterproof snap frames 25 mm*



Art.-Nr.	Format	Folie (mm)
UYUP088400X1000	DIN A3	330 x 453
UYUP088410X1000	DIN A2	453 x 627
UYUP088420X1000	DIN A1	627 x 874
UYUP088430X1000	DIN A0	874 x 1222
UYUP088440X1000	DIN B2	533 x 733
UYUP088450X1000	DIN B1	733 x 1033

Antireflex PET Schutzfolie für Klapprahmen & Kundenstopper Eco |

Antireflex cover-sheet for snap frames & A-board Eco

- Antireflex PET Schutzfolie
- **Für Klapprahmen und Kundenstopper Eco**
- *Antireflex PET cover-sheet*
- *For snap frames and A-Board Eco*



Art.-Nr.	Format	Plakatformat (mm)
UYUP083000X1000	DIN A4	210 x 297
UYUP084000X1000	DIN A3	297 x 420
UYUP085000X1000	DIN A2	420 x 594
UYUP033000X1000	DIN A1	594 x 841
UYUP086000X1000	DIN A0	841 x 1189
UYUP087000X1000	DIN B2	500 x 700
UYUP088000X1000	DIN B1	700 x 1000
UYUP089000X1000	DIN B0	1000 x 1400

Antireflex PET Schutzfolie für WindPro®/ PLUS & LITE |

Antireflex cover-sheet for WindPro®/PLUS & LITE

- Antireflex PET Schutzfolie
- **Für WindPro® "Standard", WindPro® PLUS und WindPro® LITE**
- *Antireflex PET cover-sheet*
- *For WindPro® "Standard", WindPro® PLUS and WindPro® LITE*



Art.-Nr.	Modell	Format	Plakatformat (mm)	Folie (mm)
UYUP081020X2000	Standard	DIN A1	594 x 841	623 x 870 x 0,7
UYUP081030X1000	Standard	DIN A0	841 x 1189	870 x 1218 x 1,0
UYUP081040X1000	Standard	DIN B2	500 x 700	529 x 729 x 0,7
UYUP081050X1000	Standard	DIN B1	700 x 1000	729 x 1029 x 1,0
UYUP082060X1000	PLUS	DIN A1	594 x 841	625 x 889 x 1,0
UYUP082050X1000	PLUS	DIN A0	841 x 1189	872 x 1237 x 1,0
UYUP082000X1000	PLUS	DIN B2	500 x 700	531 x 748 x 1,0
UYUP082070X1000	PLUS	DIN B1	700 x 1000	731 x 1048 x 1,0
UYUP083040X1000	LITE	DIN A1	594 x 841	594 x 841 x 0,7
UYUP083050X1000	LITE	DIN A0	841 x 1189	841 x 1189 x 1,0
UYUP083070X1000	LITE	DIN B2	500 x 700	500 x 700 x 0,7
UYUP083060X1000	LITE	DIN B1	700 x 1000	700 x 1000 x 1,0

Allgemeine Liefer- und Zahlungsbedingungen

Katalog

Wenn Sie ein Produkt in unserem Katalog nicht finden oder Sonderanfertigungen wünschen, kontaktieren Sie bitte unseren Vertrieb. Preise auf Anfrage!

Bestellungen

Bitte senden Sie uns ihre Bestellung schriftlich per E-Mail an: bestellung@update-displays.de.

Um Missverständnisse und Fehllieferungen zu vermeiden, geben Sie nach Möglichkeit immer unsere Artikelnummer mit an.

Muster

Muster werden aus organisatorischen Gründen gegen Berechnung geliefert.

Bei frachtfreier Rückgabe in der Originalverpackung und in einwandfreiem Zustand, erhalten Sie eine Gutschrift.

Varianten und Sonderanfertigungen sind von der Rückgabe ausgeschlossen.

Lieferung/ Versand

Alle Lieferungen erfolgen, soweit nicht anders vereinbart, ab Werk Troisdorf, zzgl. Fracht- und Verpackungskosten und der gesetzlichen Mehrwertsteuer, per Paketdienst oder Spedition. Bitte prüfen Sie die Lieferung direkt beim Erhalt der Waren und vermerken eventuelle Schäden auf den Frachtpapieren. Ohne einen entsprechenden Vermerk lehnen die Paketdienste und Spediteure Transportschäden generell ab und der Schaden geht dann zu ihren Lasten.

Zahlung

Soweit nicht anders vereinbart, erwarten wir ihre Zahlungen innerhalb von 10 Tagen, abzgl. 2 % Skonto oder 30 Tagen Netto, Bonität vorausgesetzt.

Gewährleistung / Umtausch

Gewährleistungsforderungen kommen wir selbstverständlich gemäß unseren Allgemeinen Geschäftsbedingungen und den gesetzlichen Bestimmungen nach.n Standardartikel können nach Rücksprache umgetauscht werden – hierfür fallen 20 % des Warenwertes, mindestens jedoch 10,- € für Überprüfung, Neuverpackung und Wiedereinlagerung an – die, ebenso wie die Transportkosten, nicht gutgeschrieben werden können. Varianten und Sonderanfertigungen sind vom Umtausch ausgeschlossen.

Druckerzeugnisse

Der Auftraggeber hat die Vertragsgemäßheit der zur Korrektur übersandten Vor- und Zwischenerzeugnisse zu überprüfen.

Die Gefahr etwaiger Fehler geht mit der Druckreif-Erklärung auf den Auftraggeber über, soweit es sich nicht um Fehler handelt, die erst in dem sich an den Druckreif-Erklärung anschließenden Produktionsvorgang entstanden sind oder erkannt werden konnten.

Das gleiche gilt für alle sonstigen Freigabeerklärungen des Kunden zur weiteren Herstellung. Geringfügige Farbabweichungen vom Original können bei farbigen Reproduktionen in allen Druckverfahren nicht beanstandet werden. Dies gilt auch für den Vergleich zwischen Andruck und Auflagendruck. Mehr- oder Minderlieferungen bis zu 10 % der bestellten Auflage, können nicht beanstandet werden. Berechnet wird die gelieferte Menge.

Gültigkeit / AGB's

Dieser Katalog ist gültig ab 1. August 2024 bis zum Erscheinen einer neuen Preisliste & Widerruf.

Über die jeweils aktuelle Version unserer Preisliste können Sie sich unter www.update-displays.de in der Rubrik Service/Kataloge informieren. Alle früheren Kataloge und Angebote verlieren hiermit ihre Gültigkeit.

Irrtümer und technische Änderungen bleiben vorbehalten.

Lieferungen erfolgen ausschließlich gemäß unseren AGB, die wir Ihnen gerne auf Wunsch zur Verfügung stellen.

Sonstiges

Druckfehler, Irrtümer, technische Änderungen, sowie Änderungen zum Inhalt, Text und Abbildungen der angebotenen Prod ten.

General terms of delivery and payment

Catalog

*In case you cannot find a product you are looking for in our pricelist, please feel free to contact our sales team.
Prices on request!*

Orders

*Please send us written orders by email to order@update-displays.de.
To avoid misunderstandings and false deliveries, please enter our article number.*

Samples

*Due to organizational reasons, a charge is always made for samples.
If the sample is returned in perfect condition and free of transportation charges, the cost of the sample will be credited
Please bear in mind that customised versions cannot be returned.*

Dispatch / Shipment

*All shipments are made "ex works Troisdorf" plus the cost of freight and VAT, except when otherwise stipulated.
The methods of dispatch are by parcel service or carrier, depending on weight and cost. Please inspect the goods on delivery in the presence of the carrier and record any damage on the freight note. Otherwise the carrier will not accept liability and you will have to bear the cost of damage.*

Payment

Your payment is due, unless otherwise agreed, within 10 days less 2% discount or within 30 days net, subject to creditworthiness.

Warranty / Exchange

*We will of course comply with warranty claims in accordance with our General Terms and Conditions and the statutory provisions.
Standard items can be returned after previous information - for this 20% of the value of the goods, but at least 10,- € for inspection, repackaging and re-storage - which, like the transport costs, cannot be credited.
Variants and custom-made products are excluded from exchange.*

Print

*The client has to check the conformity of the correction sent to primary and intermediate products.
The risk of any errors shall pass with the "print release" to the client as far as there are no errors that have arisen in the work flow after print release.
The same applies to all other release declarations by the customer for further production.
Minor colour variations from the original cannot be rejected in coloured reproductions in all printing processes.
This also applies for the comparison between proof and production prints.
Excess or short deliveries up to 10% of the ordered quantity, cannot be rejected. The quantity delivered will be invoiced.*

Validity / Terms & Conditions

*This catalog is valid from up 1th august 2024 until a new version of catalog is published.
The current version of our price list you can find at www.update-displays.de (Service/Catalogs).
All prior catalogs and calculation files are void. Errors and technical specifications are subject to change without notice.
Our general terms and conditions apply to all deliveries.
Delivered goods remain to property of update displays until payment in full.*

Others

Printing errors, mistakes and changes to the content, text and pictures of the offered products are reserved.



update displays gmbh
Belgische Allee 73
53842 Troisdorf

Telefon: +49 2241 2232-0

info@update-displays.de
www.update-displays.de

